



Lightning and surge protection for rooftop photovoltaic systems

White Paper



Contents

- Cable routing and earthing of PV systems
- Separation distance s as per IEC 62305-3 (EN 62305-3)
- Core shadows on solar cells
- Special surge protective devices for the d.c. side of PV systems
- Type 1 and 2 d.c. arrester for use in PV systems
- Selection of SPDs according to the voltage protection level U_p
- Building with and without external lightning protection system
- HVI Conductors
- Module inverters

Lightning and surge protection for rooftop photovoltaic systems

White Paper



At present, about one million PV systems are installed in Germany. Based on the fact that self-generated electricity is generally cheaper and provides a high degree of electrical independence from the grid, PV systems will become an integral part of electrical installations in the future. However, these systems are exposed to all weather conditions and must withstand them over decades.

The cables of PV systems frequently enter the building and extend over long distances until they reach the grid connection point.

Lightning discharges cause field-based and conducted electrical interference. This effect increases in relation with increasing cable lengths or conductor loops. Surges do not only damage the PV modules, inverters and their monitoring electronics, but also devices in the building installation. More importantly, production facilities of industrial buildings may also easily be damaged and production may come to a halt.

If surges are injected into systems that are far from the power grid, which are also referred to as stand-alone PV systems, the operation of equipment powered by solar electricity (e.g. medical equipment, water supply) may be disrupted.

Necessity of a rooftop lightning protection system

The energy released by a lightning discharge is one of the most frequent causes of fire. Therefore, personal and fire protection is of paramount importance in case of a direct lightning strike to the building.

At the design stage of a PV system, it is evident whether a lightning protection system is installed on a building. Some countries' building regulations require that public buildings (e.g. places of public assembly, schools and hospitals) be equipped with a lightning protection system. In case of industrial or private buildings it depends on their location, type of construction and utilisation whether a lightning protection system must be installed. To this end, it must be determined whether lightning strikes are to be expected or could have severe consequences. Structures in need of protection must be provided with permanently effective lightning protection systems.

According to the state of scientific and technical knowledge, the installation of PV modules does not increase the risk of a lightning strike. Therefore, the request for lightning protection measures cannot be derived directly from the mere existence of a PV system. However, substantial lightning interference may be injected into the building through these systems. Therefore, it is necessary to determine the risk resulting from a lightning strike as per IEC 62305-2 (EN 62305-2) and to take the results from this risk analysis into account when installing the PV system. For this purpose, DEHN offers the DEHNsupport Toolbox software which allows to determine the risk. A risk analysis performed by means of this software provides a re-

sult which is understood by all parties involved. The software compares the risk with the technical expenditure and provides economically optimised protection measures.

Section 4.5 (Risk Management) of Supplement 5 of the German DIN EN 62305-3 standard describes that a lightning protection system designed for class of LPS III (LPL III) meets the usual requirements for PV systems. In addition, adequate lightning protection measures are listed in the German VdS 2010 guideline (Risk-oriented lightning and surge protection) published by the German Insurance Association. This guideline also requires that LPL III and thus a lightning protection system according to class of LPS III be installed for rooftop PV systems (> 10 kW_p) and that surge protection measures be taken.

As a general rule, rooftop photovoltaic systems must not interfere with the existing lightning protection measures.

Necessity of surge protection for PV systems

In case of a lightning discharge, surges are induced on electrical conductors. Surge protective devices (SPDs) which must be installed upstream of the devices to be protected on the a.c., d.c. and data side have proven very effective in protecting electrical systems from these destructive voltage peaks. Section 9.1 of the CENELEC CLC/TS 50539-12 standard (Selection and application principles – SPDs connected to photovoltaic installations) calls for the installation of surge protective devices unless a risk analysis demonstrates that SPDs are not required. According to the IEC 60364-4-44 (HD 60364-4-44) standard, surge protective devices must also be installed for buildings without external lightning protection system such as commercial and industrial buildings, e.g. agricultural facilities. Supplement 5 of the German DIN EN 62305-3 standard provides a detailed description of the types of SPDs and their place of installation.

Cable routing of PV systems

Cables must be routed in such a way that large conductor loops are avoided. This must be observed when combining the d.c. circuits to form a string and when interconnecting several strings. Moreover, data or sensor lines must not be routed over several strings and form large conductor loops with the string lines. This must also be observed when connecting the inverter to the grid connection. For this reason, the power (d.c. and a.c.) and data lines (e.g. radiation sensor, yield monitoring) must be routed together with the equipotential bonding conductors along their entire route.

Earthing of PV systems

PV modules are typically fixed on metal mounting systems. The live PV components on the d.c. side feature double or reinforced insulation (comparable to the previous protective

Lightning and surge protection for rooftop photovoltaic systems

White Paper

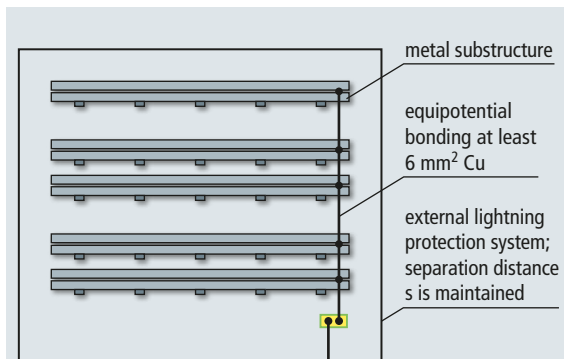

Figure 1 Functional earthing of the mounting systems if no external lightning protection system is installed or the separation distance is maintained (DIN EN 62305-3, Supplement 5)

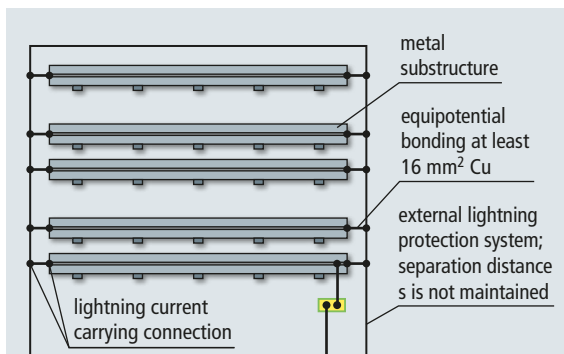

Figure 2 Lightning equipotential bonding for the mounting systems if the separation distance is not maintained



Figure 3 UNI earthing clamp: A stainless steel intermediate element prevents contact corrosion, thus establishing reliable long-term connections between different conductor materials

insulation) as required in the IEC 60364-4-41 standard. The combination of numerous technologies on the module and inverter side (e.g. with or without galvanic isolation) results in different earthing requirements. Moreover, the insulation monitoring system integrated in the inverters is only permanently effective if the mounting system is connected to earth. Information on the practical implementation is provided in Supplement 5 of the German DIN EN 62305-3 standard. The metal substructure is functionally earthed if the PV system is located in the protected volume of the air-termination systems and the separation distance is maintained. Section 7 of Supplement 5 requires copper conductors with a cross-section of at least 6 mm^2 or equivalent for functional earthing (Figure 1). The mounting rails also have to be permanently interconnected by means of conductors of this cross-section. If the mounting system is directly connected to the external lightning protection system due to the fact that the separation distance s cannot be maintained, these conductors become part of the lightning equipotential bonding system. Consequently, these elements must be capable of carrying lightning currents. The minimum requirement for a lightning protection system designed for class of LPS III is a copper conductor with a cross-section of 16 mm^2 or equivalent. Also in this case, the mounting rails must be permanently interconnected by means of conductors of this cross-section (Figure 2). The functional earthing/lightning equipotential bonding conductor should be routed in parallel and as close as possible to the d.c. and a.c. cables/lines.

UNI earthing clamps (Figure 3) can be fixed on all common mounting systems. They connect, for example, copper conductors with a cross-section of 6 or 16 mm^2 and bare round wires with a diameter from 8 to 10 mm to the mounting system in such a way that they can carry lightning currents. The integrated stainless steel (V4A) contact plate ensures corrosion protection for the aluminium mounting systems.

Separation distance s as per IEC 62305-3 (EN 62305-3)

A certain separation distance s must be maintained between a lightning protection system and a PV system. It defines the distance required to avoid uncontrolled flashover to adjacent metal parts resulting from a lightning strike to the external lightning protection system. In the worst case, such an uncontrolled flashover can set a building on fire. In this case, damage to the PV system becomes irrelevant. Details on the calculation of the separation distance s can be found in chapter 5.6 and can be easily and quickly calculated by means of the DEHN Distance Tool software (chapter 3.3.2).

Core shadows on solar cells

The distance between the solar generator and the external lightning protection system is absolutely essential to prevent excessive shading. Diffuse shadows cast by, for example

Lightning and surge protection for rooftop photovoltaic systems

White Paper



overhead lines, do not significantly affect the PV system and the yield. However, in case of core shadows, a dark clearly outlined shadow is cast on the surface behind an object, changing the current flowing through the PV modules. For this reason, solar cells and the associated bypass diodes must not be influenced by core shadows. This can be achieved by maintaining a sufficient distance. For example, if an air-termination rod with a diameter of 10 mm shades a module, the core shadow is steadily reduced as the distance from the module increases. After 1.08 m only a diffuse shadow is cast on the module (Figure 4). Annex A of Supplement 5 of the German DIN EN 62305-3 standard provides more detailed information on the calculation of core shadows.

Special surge protective devices for the d.c. side of photovoltaic systems

The UI characteristics of photovoltaic current sources are very different from that of conventional d.c. sources: They have a non-linear characteristic (Figure 5) and cause long-term persistence of ignited arcs. This unique nature of PV current sources does not only require larger PV switches and PV fuses, but also a disconnecter for the surge protective device which is adapted to this unique nature and capable of coping with PV currents. Supplement 5 of the German DIN EN 62305-3 standard (subsection 5.6.1, Table 1) describes the selection of adequate SPDs.

To facilitate the selection of type 1 SPDs, Tables 1 and 2 shown the required lightning impulse current carrying capability I_{imp} depending on the class of LPS, number of down conductors of the external lightning protection systems as well as the SPD type (voltage-limiting varistor-based arrester or voltage-switching spark-gap-based arrester). SPDs which comply with the applicable EN 50539-11 standard must be used. Subsection 9.2.2.7 of CENELEC CLC/TS 50539-12 also refers to this standard.

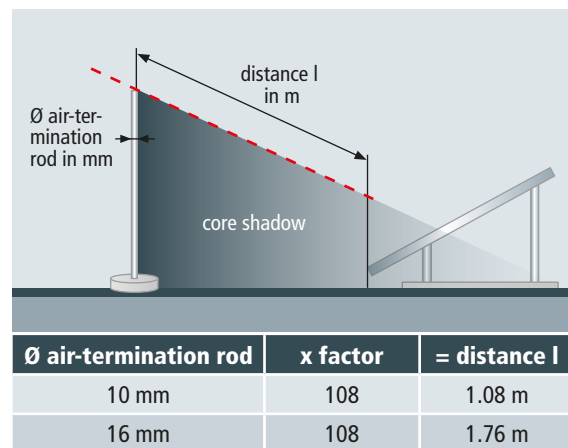

Figure 4 Distance between the module and the air-termination rod required to prevent core shadows

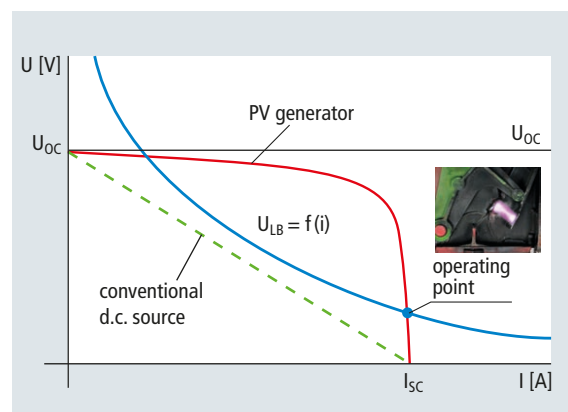

Figure 5 Source characteristic of a conventional d.c. source versus the source characteristic of a PV generator. When switching PV sources, the source characteristic of the PV generator crosses the arc voltage range

Class of LPS and max. lightning current (10/350 µs)		Number of down conductors of the external lightning protection system			
		< 4		≥ 4	
		Values for the voltage-limiting type 1 SPDs or type 1 combined SPDs (series connection) based on a selection of $I_{8/20}$ (8/20 µs) and $I_{10/350}$ (10/350 µs)			
		$I_{SPD1} = I_{SPD2}$ $I_{8/20}/I_{10/350}$	$I_{SPD3} = I_{SPD1} + I_{SPD2} = I_{total}$ $I_{8/20}/I_{10/350}$	$I_{SPD1} = I_{SPD2}$ $I_{8/20}/I_{10/350}$	$I_{SPD3} = I_{SPD1} + I_{SPD2} = I_{total}$ $I_{8/20}/I_{10/350}$
I or unknown	200 kA	17/10	34/20	10/5	20/10
II	150 kA	12.5/7.5	25/15	7.5/3.75	15/7.5
III and IV	100 kA	8.5/5	17/10	5/2.5	10/5

Table 1 Selection of the minimum discharge capacity of voltage-limiting type 1 SPDs (varistors) or type 1 combined SPDs (series connection of varistors and spark gaps); according to CENELEC CLC/TS 50539-12 (Table A.1)

Lightning and surge protection for rooftop photovoltaic systems

White Paper



Class of LPS and max. lightning current (10/350 μ s)		Number of down conductors of the external lightning protection system			
		< 4		≥ 4	
		Values for the voltage-switching type 1 SPDs or type 1 combined SPDs (parallel connection)			
		$I_{SPD1} = I_{SPD2}$ I_{imp}	$I_{SPD3} = I_{SPD1} + I_{SPD2} = I_{total}$ I_{imp}	$I_{SPD1} = I_{SPD2}$ I_{imp}	$I_{SPD3} = I_{SPD1} + I_{SPD2} = I_{total}$ I_{imp}
I or unknown	200 kA	25	50	12.5	25
II	150 kA	18.5	37.5	9	18
III and IV	100 kA	12.5	25	6.25	12.5

Table 2 Selection of the minimum discharge capacity of voltage-switching type 1 SPDs (spark gaps) or type 1 combined SPDs (parallel connection of varistors and spark gaps); according to CENELEC CLC/TS 50539-12 (Table A.2)



Figure 6 DEHNcombo YPV SCI type 1 combined arrester for protecting photovoltaic systems from surges and partial lightning currents

Type 1 d.c. arrester for use in PV systems: Multipole type 1 + type 2 combined d.c. arrester, DEHNcombo YPV SCI (FM)

With their integrated SCI technology, DEHNcombo YPV SCI (FM) combined arresters (Figure 6) fulfil the above mentioned requirements. In addition to the proven fault-resistant Y circuit, DEHNcombo YPV SCI (FM) features a three-step d.c. switching device (SCI technology). This d.c. switching device consists of a combined disconnection and short-circuiting device with Thermo Dynamic Control and a fuse in the bypass path. This circuit (Figure 7) safely disconnects the arrester from the generator voltage in case of an overload and reliably extinguishes d.c. arcs. Thus, DEHNcombo YPV SCI (FM) allows to protect PV generators up to 1000 A without additional backup fuse. This arrester combines a lightning current arrester and a surge arrester in a single device, thus ensuring efficient protection of terminal equipment. With its discharge capacity I_{total} of 12.5 kA (10/350 μ s), it can be flexibly used for the highest classes of LPS. DEHNcombo YPV SCI (FM)

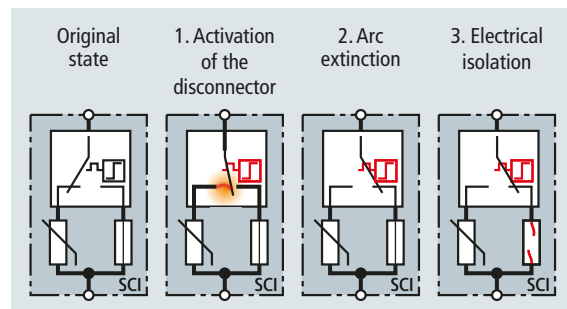

Figure 7 Switching phases of the three-step d.c. switching device integrated in DEHNguard M YPV SCI ... (FM)

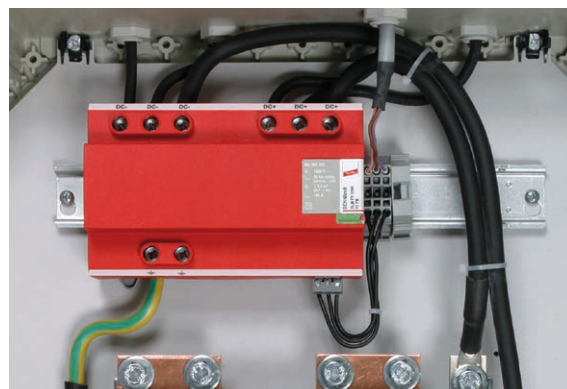

Figure 8 DEHNlimit PV 1000 V2 spark-gap-based type 1 combined arrester

is available for voltages U_{CPV} of 600 V, 1000 V and 1500 V and has a width of only 4 modules. Therefore, DEHNcombo YPV SCI (FM) is the ideal type 1 combined arrester for use in photovoltaic power supply systems.

Voltage-switching spark-gap-based type 1 SPDs, for example DEHNlimit PV 1000 V2 (Figure 8), are another powerful

Lightning and surge protection for rooftop photovoltaic systems

White Paper

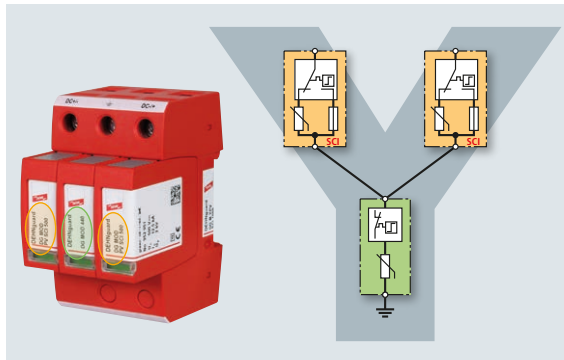

Figure 9 Modular DEHNgard M YPV SCI ... (FM) type 2 surge arrester with fault-resistant Y circuit and three-step d.c. switching device



Figure 10 Ready-to-install type 2 DEHncube YPV SCI 1000 1M surge arrester

technology that allows to discharge partial lightning currents in case of d.c. PV systems. Thanks to its spark gap technology and a d.c. extinction circuit which allow to efficiently protect downstream electronic systems, this arrester series has an extremely high lightning current discharge capacity I_{total} of 50 kA (10/350 μ s) which is unique on the market.

Type 2 d.c. arrester for use in PV systems: DEHNgard M YPV SCI ... (FM) and DEHncube YPV SCI ...

Reliable operation of SPDs in d.c. PV circuits is also indispensable when using type 2 surge protective devices. To this end, the DEHNgard M YPV SCI ... (FM) and DEHncube YPV SCI ... surge arresters also feature a fault-resistant Y protective circuit and the SCI technology (Figure 9 and 10) and are also connected to PV generators up to 1000 A without additional backup fuse.



Figure 11 DEHNgard type 2 SPD integrated in the inverter for the a.c. and d.c. side

The numerous technologies combined in these arresters prevent damage to the surge protective device due to insulation faults in the PV circuit, the risk of fire of an overloaded arrester and puts the arrester in a safe electrical state without disrupting the operation of the PV system. Thanks to the protective circuit, the voltage-limiting characteristic of varistors can be fully used even in the d.c. circuits of PV systems. In addition, the permanently active surge protective device minimises numerous small voltage peaks. Thus, the SCI technology increases the service life of the entire d.c.-side PV system.

Selection of SPDs according to the voltage protection level U_p

The operating voltage on the d.c. side of PV systems differs from system to system. At present, values up to 1500 V d.c. are possible. Consequently, the dielectric strength of terminal equipment also differs. To ensure that the PV system is reliably protected, the voltage protection level U_p of the SPD must be lower than the dielectric strength of the PV system it is supposed to protect. The CENELEC CLC/TS 50539-12 standard requires that U_p is at least 20% lower than the dielectric strength of the PV system. Type 1 or type 2 SPDs must be energy-coordinated with the input of terminal equipment. If SPDs are already integrated in terminal equipment, coordination between the type 2 SPD and the input circuit of terminal equipment is ensured by the manufacturer (Figure 11).

Lightning and surge protection for rooftop photovoltaic systems

White Paper

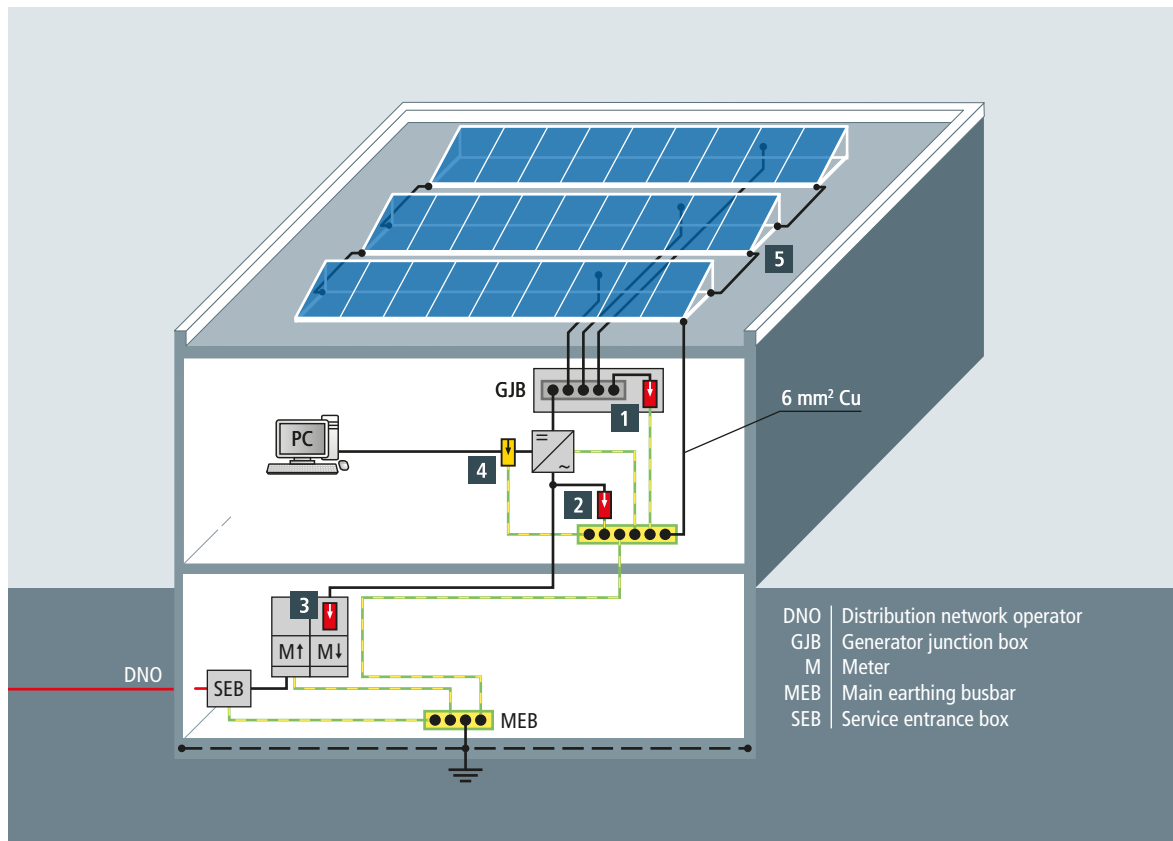

No. in Fig.		SPD	* FM = Floating remote signalling contact	Part No.
d.c. input of the inverter				
1	Per MPPT	DEHNguard DG M YPV SCI 1000 FM *		952 515
	For 1 MPPT	DEHNcube DCU YPV SCI 1000 1M		900 910
	For 2 MPPTs	DEHNcube DCU YPV SCI 1000 2M		900 920
a.c. output of the inverter				
2	TN-S system	DEHNguard DG M TNS 275 FM *		952 405
Low-voltage input				
3	TN-C system	DEHNguard DG M TNC CI 275 FM *		952 309
	TN-S system	DEHNguard DG M TNS CI 275 FM *		952 406
	TT system	DEHNguard DG M TT CI 275 FM *		952 327
Data interface				
4	Two pairs, even with different operating voltages up to 180 V	BLITZDUCTOR BXTU ML4 BD 0-180 + BXT BAS base part		920 349 + 920 300
Functional earthing				
5	Functional equipotential bonding	UNI earthing clamp		540 250

Figure 12 Building without external LPS – situation A (Supplement 5 of the DIN EN 62305-3 standard)

Lightning and surge protection for rooftop photovoltaic systems

White Paper

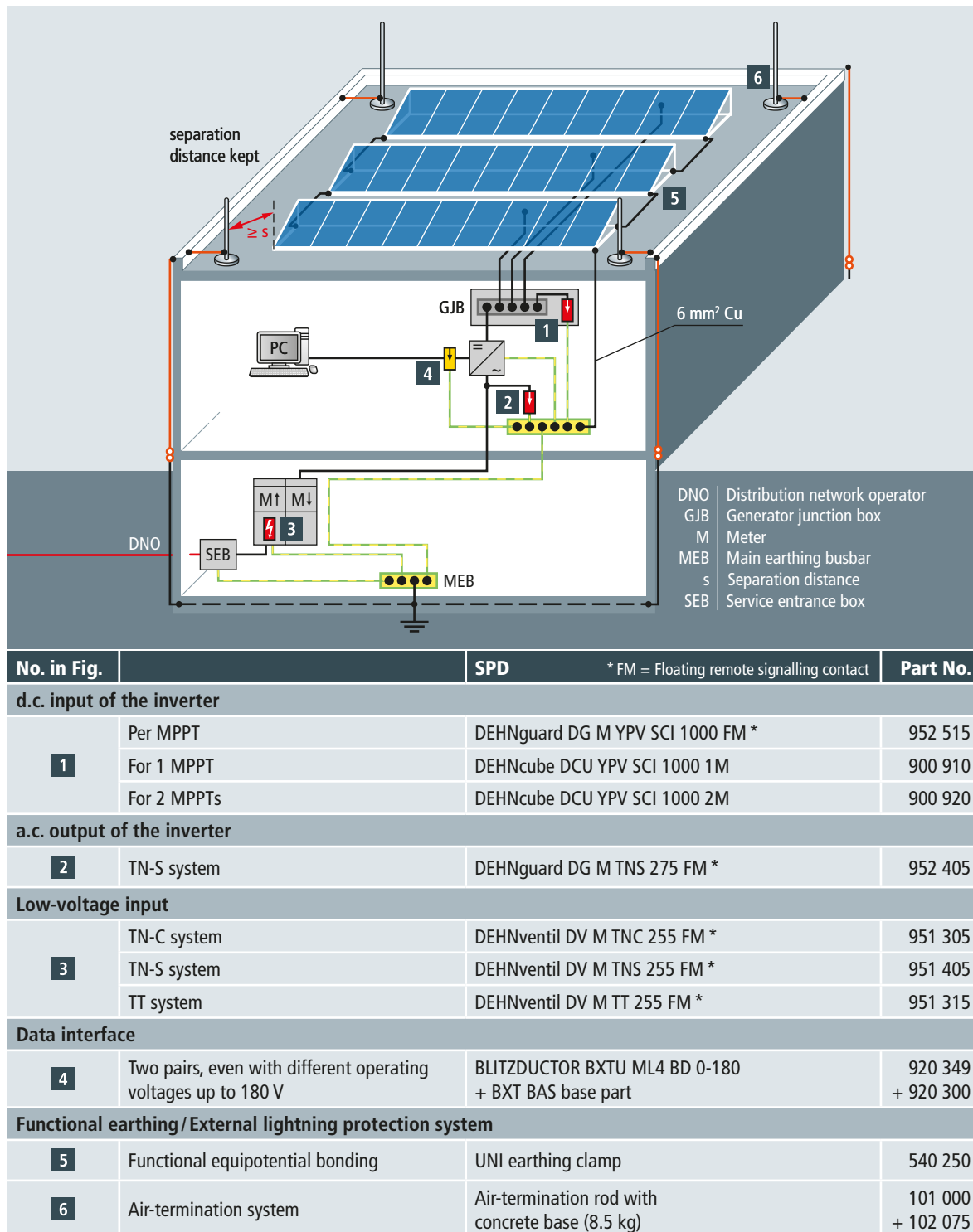

Figure 13 Building with external LPS and sufficient separation distance – situation B (Supplement 5 of the DIN EN 62305-3 standard)

Lightning and surge protection for rooftop photovoltaic systems

White Paper



Figure 14 Determination of the protected volume using the protective angle method

Application examples:

Building without external lightning protection system (situation A)

Figure 12 shows the surge protection concept for a PV system installed on a building without external lightning protection system. Dangerous surges enter the PV system due to inductive coupling resulting from nearby lightning strikes or travel from the power supply system through the service entrance to the consumer's installation. Type 2 SPDs are to be installed at the following locations:

- ➔ d.c. side of the modules and inverters
- ➔ a.c. output of the inverter
- ➔ Main low-voltage distribution board
- ➔ Wired communication interfaces

Every d.c. input (MPP) of the inverter must be protected by a type 2 surge protective device, for example DEHNgard M YPV SCI ... (FM), that reliably protects the d.c. side of PV systems. The CENELEC CLC/TS 50539-12 standard requires

that an additional type 2 d.c. arrester be installed on the module side if the distance between the inverter input and the PV generator exceeds 10 m.

The a.c. outputs of the inverters are sufficiently protected if the distance between the PV inverters and the place of installation of the type 2 arrester at the grid connection point (low-voltage infeed) is less than 10 m. In case of greater cable lengths, an additional type 2 surge protective device, for example DEHNgard M ... 275, must be installed upstream of the a.c. input of the inverter as per CENELEC CLC/TS 50539-12.

Moreover, a type 2 DEHNgard M ... CI 275 (FM) surge protective device must be installed upstream of the meter of the low-voltage infeed. CI (Circuit Interruption) stands for a coordinated fuse integrated in the protective path of the arrester, allowing the arrester to be used in the a.c. circuit without additional backup fuse. DEHNgard M ... CI 275 (FM) is available for every low-voltage system configuration (TN-C, TN-S, TT).

If inverters are connected to data and sensor lines to monitor the yield, suitable surge protective devices are required. BLITZDUCTOR XTU, which features terminals for two pairs, for example for incoming and outgoing data lines, can be used for data systems based on RS 485.

Building with external lightning protection system and sufficient separation distance s (situation B)

Figure 13 shows the surge protection concept for a PV system with external lightning protection system and sufficient separation distance s between the PV system and the external lightning protection system.

The primary protection goal is to avoid damage to persons and property (building fire) resulting from a lightning strike. In this context, it is important that the PV system does not interfere with the external lightning protection system. Moreover, the PV system itself must be protected from direct lightning strikes. This means that the PV system must be installed in the protected volume of the external lightning protection system. This protected volume is formed by air-termination systems (e.g. air-termination rods) which prevent direct lightning strikes to the PV modules and cables. The protective angle method (Figure 14) or rolling sphere method (Figure 15) as described in subsection 5.2.2 of the IEC 62305-3 (EN 62305-3) standard may be used to determine this protected volume. A certain separation distance s must be maintained between all conductive parts of the PV system and the lightning protection system. In this context,

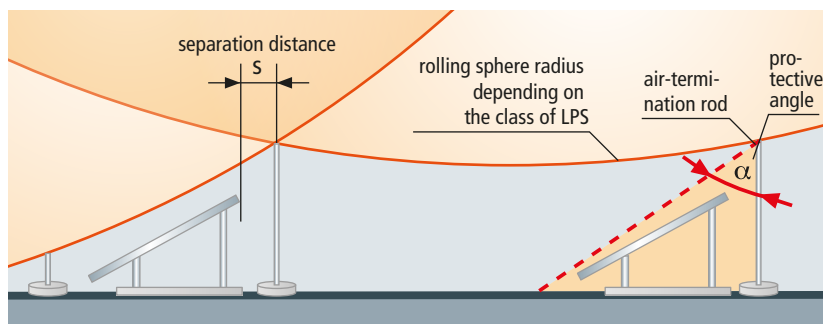

Figure 15 Rolling sphere method versus protective angle method for determining the protected volume

Lightning and surge protection for rooftop photovoltaic systems

White Paper



Figure 16 DEHNcube YPV SCI 1000 1M type 2 arrester for protecting inverters (1 MPPT)

core shadows must be prevented by, for example, maintaining a sufficient distance between the air-termination rods and the PV module.

Lightning equipotential bonding is an integral part of a lightning protection system. It must be implemented for all conductive systems and lines entering the building which may carry lightning currents. This is achieved by directly connecting all metal systems and indirectly connecting all energised systems via type 1 lightning current arresters to the earth-termination system. Lightning equipotential bonding should be implemented as close as possible to the entrance point into the building to prevent partial lightning currents from entering the building. The grid connection point must be protected by a multipole spark-gap-based type 1 SPD, for example a type 1 DEHNventil M ... 255 combined arrester. This arrester combines a lightning current arrester and a surge arrester in a single device. If the cable lengths between the arrester and the inverter are less than 10 m, sufficient protection is provided. In case of greater cable lengths, additional type 2 DEHNguard M surge protective devices must be installed upstream of the a.c. input of the inverters as per CENELEC CLC/TS 50539-12.

Every d.c. input of the inverter must be protected by a type 2 PV arrester, for example DEHNcube YPV SCI ... (Figure 16). This also applies to transformerless devices. If the inverters are connected to data lines, for example to monitor the yield, surge protective devices must be installed to protect data transmission. For this purpose, BLITZDUCTOR XTU with actiVsense technology can be provided for lines with analogue signal and data bus systems such as RS485. It au-

tomatically detects the operating voltage of the useful signal and adjusts the voltage protection level to this operating voltage.

High-voltage-resistant, insulated HVI Conductor

Another possibility to maintain the separation distance s is to use high-voltage-resistant, insulated HVI Conductors which allow to maintain a separation distance s up to 0.9 m in air. HVI Conductors may directly contact the PV system downstream of the sealing end range. More detailed information on the application and installation of HVI Conductors is provided in this Lightning Protection Guide or in the relevant installation instructions.

Building with external lightning protection system with insufficient separation distance s (situation C)

If the roofing is made of metal or is formed by the PV system itself, the separation distance s cannot be maintained. The metal components of the PV mounting system must be connected to the external lightning protection system in such a way that they can carry lightning currents (copper conductor with a cross-section of at least 16 mm² or equivalent). This means that lightning equipotential bonding must also be implemented for the PV lines entering the building from the outside (Figure 17). According to Supplement 5 of the German DIN EN 62305-3 standard and the CENELEC CLC/TS 50539-12 standard, d.c. lines must be protected by a type 1 SPD for PV systems.

For this purpose, a type 1 and type 2 DEHNcomboYPV SCI (FM) combined arrester is used. Lightning equipotential bonding must also be implemented in the low-voltage infeed. If the PV inverter(s) is (are) situated more than 10 m from the type 1 SPD installed at the grid connection point, an additional type 1 SPD must be installed on the a.c. side of the inverter(s) (e.g. type 1 + type 2 DEHNshield ... 255 combined arrester). Suitable surge protective devices must also be installed to protect the relevant data lines for yield monitoring. BLITZDUCTOR XTU surge protective devices are used to protect data systems, for example based on RS 485.

PV systems with microinverters

Microinverters require a different surge protection concept. To this end, the d.c. line of a module or a pair of modules is directly connected to the small-sized inverter. In this process, unnecessary conductor loops must be avoided. Inductive coupling into such small d.c. structures typically only has a low energetic destruction potential. The extensive cabling of a PV system with microinverters is located on the a.c. side (Figure 18). If the microinverter is directly fitted at the module, surge protective devices may only be installed on the a.c. side:

Lightning and surge protection for rooftop photovoltaic systems

White Paper

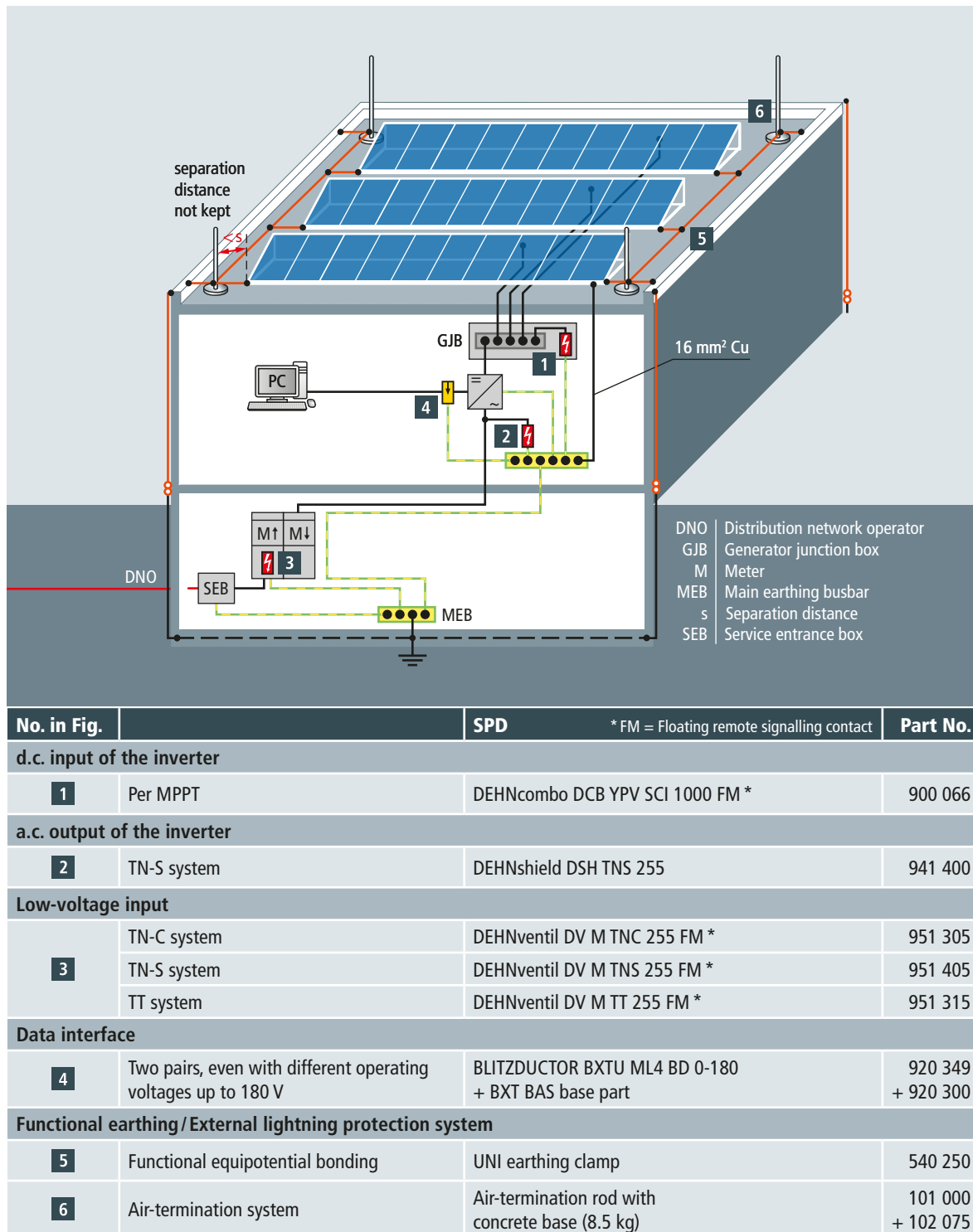

Figure 17 Building with external LPS and insufficient separation distance – situation C (Supplement 5 of the DIN EN 62305-3 standard)

Lightning and surge protection for rooftop photovoltaic systems

White Paper

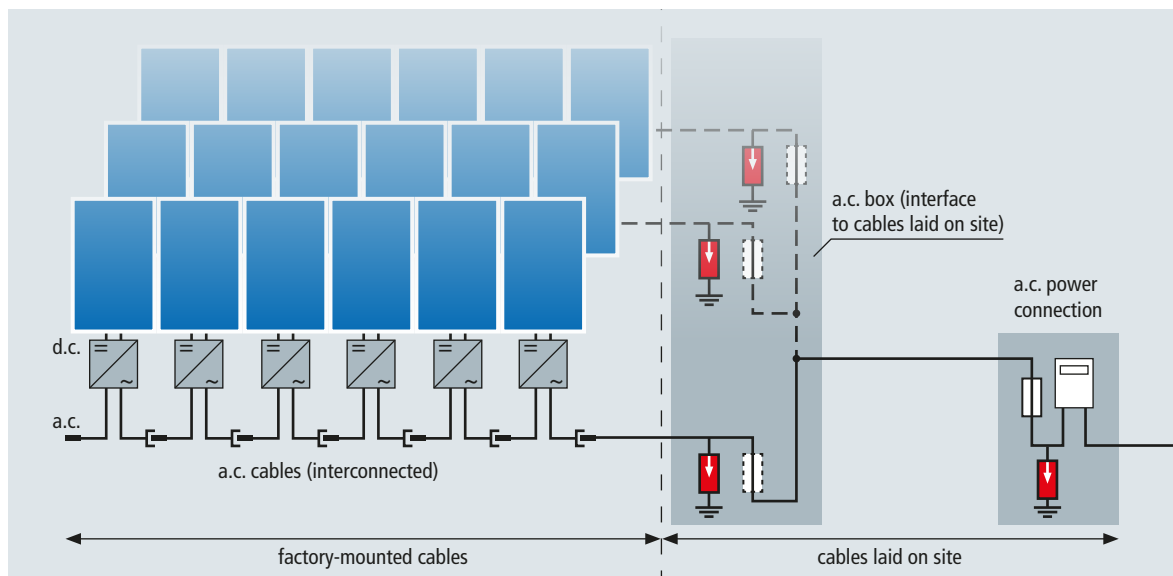

Figure 18 Example: Building without external lightning protection system; surge protection for a microinverter located in the connection box of the on-site cables

- ➔ Buildings without external lightning protection system = type 2 DEHNguard M...275 arresters for alternating/three-phase current in close proximity to the microinverters and DEHNguard...275 CI at the low-voltage infeed.
- ➔ Buildings with external lightning protection system and sufficient separation distance s = type 2 arresters, for example DEHNguard M...275, in close proximity to the microinverters and lightning current carrying type 1 arresters at the low-voltage infeed, for example DEHNventil M...255.
- ➔ Buildings with external lightning protection system and insufficient separation distance s = type 1 arresters, for example DEHNshield...255, in close proximity to the

microinverters and lightning current carrying type 1 DEHNventil M...255 arresters at the low-voltage infeed.

Independent of particular manufacturers, microinverters feature data monitoring systems. If data is modulated to the a.c. lines via the microinverters, a surge protective device (for example DEHNbox DBX KT BD) must be provided on the separate receiving units (data export/data processing). The same applies to interface connections with downstream bus systems and their voltage supply (e.g. Ethernet, ISDN).

Solar power generation systems are an integral part of today's electrical systems. They should be equipped with adequate lightning current and surge arresters, thus ensuring long-term faultless operation of these sources of electricity.

DEHNventil

DV M TNC 255 FM (951 305)

- Prewired combined type 1 and type 2 spark-gap-based lightning current and surge arrester consisting of a base part and plug-in protection modules
- Maximum system availability due to RADAX Flow follow current limitation
- Capable of protecting terminal equipment



Figure without obligation

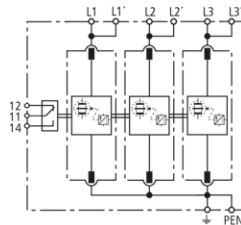

Basic circuit diagram DV M TNC 255 FM

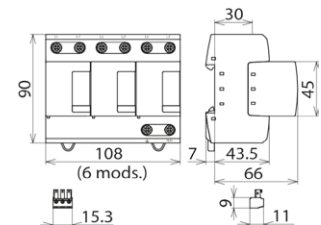

Dimension drawing DV M TNC 255 FM

Modular combined lightning current and surge arrester for TN-C systems.

Type Part No.	DV M TNC 255 FM 951 305
SPD according to EN 61643-11 / IEC 61643-11	type 1 + type 2 / class I + class II
Energy coordination with terminal equipment (≤ 5 m)	type 1 + type 2 + type 3
Nominal a.c. voltage (U_N)	230 / 400 V (50 / 60 Hz)
Max. continuous operating a.c. voltage (U_C)	264 V (50 / 60 Hz)
Lightning impulse current (10/350 μ s) [L1+L2+L3-PEN] (I_{total})	75 kA
Specific energy [L1+L2+L3-PEN] (W/R)	1.40 MJ/ohms
Lightning impulse current (10/350 μ s) [L-PEN] (I_{imp})	25 kA
Specific energy [L-PEN] (W/R)	156.25 kJ/ohms
Nominal discharge current (8/20 μ s) [L-PEN]/[L1+L2+L3-PEN] (I_n)	25 / 75 kA
Voltage protection level (U_p)	≤ 1.5 kV
Follow current extinguishing capability a.c. (I_n)	50 kA _{rms}
Follow current limitation / Selectivity	no tripping of a 20 A gL/gG fuse up to 50 kA _{rms} (prosp.)
Response time (t_A)	≤ 100 ns
Max. backup fuse (L) up to $I_k = 50$ kA _{rms}	315 A gG
Max. backup fuse (L-L')	125 A gG
Temporary overvoltage (TOV) (U_T) – Characteristic	440 V / 120 min. – withstand
Operating temperature range [parallel] / [series] (T_U)	-40 °C ... +80 °C / -40 °C ... +60 °C
Operating state / fault indication	green / red
Number of ports	1
Cross-sectional area (L1, L1', L2, L2', L3, L3', PEN, \pm) (min.)	10 mm ² solid / flexible
Cross-sectional area (L1, L2, L3, PEN) (max.)	50 mm ² stranded / 35 mm ² flexible
Cross-sectional area (L1', L2', L3', \pm) (max.)	35 mm ² stranded / 25 mm ² flexible
For mounting on	35 mm DIN rails acc. to EN 60715
Enclosure material	thermoplastic, red, UL 94 V-0
Place of installation	indoor installation
Degree of protection	IP 20
Capacity	6 module(s), DIN 43880
Approvals	KEMA, VDE, UL, VdS
Type of remote signalling contact	changeover contact
a.c. switching capacity	250 V / 0.5 A
d.c. switching capacity	250 V / 0.1 A; 125 V / 0.2 A; 75 V / 0.5 A
Cross-sectional area for remote signalling terminals	max. 1.5 mm ² solid / flexible
Extended technical data:	Use in switchgear installations with prospective short-circuit currents of more than 50 kA _{rms} (tested by the German VDE)
– Max. prospective short-circuit current	100 kA _{rms} (220 kA _{peak})
– Limitation / Extinction of mains follow currents	up to 100 kA _{rms} (220 kA _{peak})
– Max. backup fuse (L) up to $I_k = 100$ kA _{rms}	315 A gL/gG
Weight	962 g
Customs tariff number	85363030
GTIN	4013364108141
PU	1 pc(s)

DEHNventil

DV M TT 255 FM (951 315)

- Prewired spark-gap-based type 1 and type 2 combined lightning current and surge arrester consisting of a base part and plug-in protection modules
- Maximum system availability due to RADAX Flow follow current limitation
- Capable of protecting terminal equipment



Figure without obligation

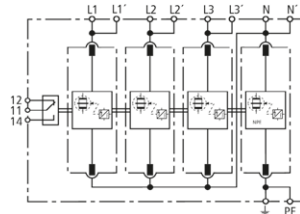

Basic circuit diagram DV M TT 255 FM

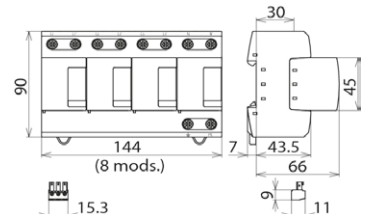

Dimension drawing DV M TT 255 FM

Modular combined lightning current and surge arrester for TT and TN-S systems ("3+1" circuit).

Type Part No.	DV M TT 255 FM 951 315
SPD according to EN 61643-11 / IEC 61643-11	type 1 + type 2 / class I + class II
Energy coordination with terminal equipment (≤ 5 m)	type 1 + type 2 + type 3
Nominal a.c. voltage (U_N)	230 / 400 V (50 / 60 Hz)
Max. continuous operating a.c. voltage [L-N] (U_C)	264 V (50 / 60 Hz)
Max. continuous operating a.c. voltage [N-PE] ($U_{C(N-PE)}$)	255 V (50 / 60 Hz)
Lightning impulse current (10/350 μ s) [L1+L2+L3+N-PE] (I_{total})	100 kA
Specific energy [L1+L2+L3+N-PE] (W/R)	2.50 MJ/ohms
Lightning impulse current (10/350 μ s) [L-N]/[N-PE] (I_{imp})	25 / 100 kA
Specific energy [L-N]/[N-PE] (W/R)	156.25 kJ/ohms / 2.50 MJ/ohms
Nominal discharge current (8/20 μ s) [L-N]/[N-PE] (I_n)	25 / 100 kA
Voltage protection level [L-N]/[N-PE] (U_p)	≤ 1.5 / ≤ 1.5 kV
Follow current extinguishing capability [L-N]/[N-PE] (I_n)	50 kA _{rms} / 100 A _{rms}
Follow current limitation / Selectivity	no tripping of a 20 A gL/gG fuse up to 50 kA _{rms} (prosp.)
Response time (t_A)	≤ 100 ns
Max. backup fuse (L) up to $I_k = 50$ kA _{rms}	315 A gG
Max. backup fuse (L-L')	125 A gG
Temporary overvoltage (TOV) [L-N] (U_T) – Characteristic	440 V / 120 min. – withstand
Temporary overvoltage (TOV) [N-PE] (U_T) – Characteristic	1200 V / 200 ms – withstand
Operating temperature range [parallel] / [series] (T_U)	-40 °C ... +80 °C / -40 °C ... +60 °C
Operating state / fault indication	green / red
Number of ports	1
Cross-sectional area (L1, L1', L2, L2', L3, L3', N, N', PE, \pm) (min.)	10 mm ² solid / flexible
Cross-sectional area (L1, L2, L3, N, PE) (max.)	50 mm ² stranded / 35 mm ² flexible
Cross-sectional area (L1', L2', L3', N', \pm) (max.)	35 mm ² stranded / 25 mm ² flexible
For mounting on	35 mm DIN rails acc. to EN 60715
Enclosure material	thermoplastic, red, UL 94 V-0
Place of installation	indoor installation
Degree of protection	IP 20
Capacity	8 module(s), DIN 43880
Approvals	KEMA, VDE, UL, VdS
Type of remote signalling contact	changeover contact
a.c. switching capacity	250 V / 0.5 A
d.c. switching capacity	250 V / 0.1 A; 125 V / 0.2 A; 75 V / 0.5 A
Cross-sectional area for remote signalling terminals	max. 1.5 mm ² solid / flexible
Extended technical data:	Use in switchgear installations with prospective short-circuit currents of more than 50 kA _{rms} (tested by the German VDE)
– Max. prospective short-circuit current	100 kA _{rms} (220 kA _{peak})
– Limitation / Extinction of mains follow currents	up to 100 kA _{rms} (220 kA _{peak})
– Max. backup fuse (L) up to $I_k = 100$ kA _{rms}	315 A gL/gG
Weight	1,28 kg
Customs tariff number	85363030
GTIN	4013364108189
PU	1 pc(s)

DEHNventil

DV M TNS 255 FM (951 405)

- Prewired spark-gap-based type 1 and type 2 combined lightning current and surge arrester consisting of a base part and plug-in protection modules
- Maximum system availability due to RADAX Flow follow current limitation
- Capable of protecting terminal equipment



Figure without obligation

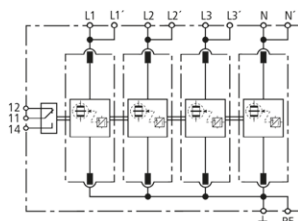

Basic circuit diagram DV M TNS 255 FM

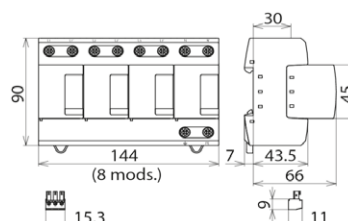

Dimension drawing DV M TNS 255 FM

Modular combined lightning current and surge arrester for TN-S systems.

Type	DV M TNS 255 FM
Part No.	951 405
SPD according to EN 61643-11 / IEC 61643-11	type 1 + type 2 / class I + class II
Energy coordination with terminal equipment (≤ 5 m)	type 1 + type 2 + type 3
Nominal a.c. voltage (U_N)	230 / 400 V (50 / 60 Hz)
Max. continuous operating a.c. voltage (U_C)	264 V (50 / 60 Hz)
Lightning impulse current (10/350 μ s) [L1+L2+L3+N-PE] (I_{total})	100 kA
Specific energy [L1+L2+L3+N-PE] (W/R)	2.50 MJ/ohms
Lightning impulse current (10/350 μ s) [L, N-PE] (I_{imp})	25 kA
Specific energy [L,N-PE] (W/R)	156.25 kJ/ohms
Nominal discharge current (8/20 μ s) [L/N-PE]/[L1+L2+L3+N-PE] (I_n)	25 / 100 kA
Voltage protection level [L-PE]/[N-PE] (U_p)	≤ 1.5 / ≤ 1.5 kV
Follow current extinguishing capability a.c. (I_{fl})	50 kA _{rms}
Follow current limitation / Selectivity	no tripping of a 20 A gL/gG fuse up to 50 kA _{rms} (prosp.)
Response time (t_A)	≤ 100 ns
Max. backup fuse (L) up to $I_k = 50$ kA _{rms}	315 A gG
Max. backup fuse (L-L')	125 A gG
Temporary overvoltage (TOV) [L-N] (U_T) – Characteristic	440 V / 120 min. – withstand
Operating temperature range [parallel] / [series] (T_U)	-40 °C ... +80 °C / -40 °C ... +60 °C
Operating state / fault indication	green / red
Number of ports	1
Cross-sectional area (L1, L1', L2, L2', L3, L3', N, N', PE, \pm) (min.)	10 mm ² solid / flexible
Cross-sectional area (L1, L2, L3, N, PE) (max.)	50 mm ² stranded / 35 mm ² flexible
Cross-sectional area (L1', L2', L3', N', \pm) (max.)	35 mm ² stranded / 25 mm ² flexible
For mounting on	35 mm DIN rails acc. to EN 60715
Enclosure material	thermoplastic, red, UL 94 V-0
Place of installation	indoor installation
Degree of protection	IP 20
Capacity	8 module(s), DIN 43880
Approvals	KEMA, VDE, UL, VdS
Type of remote signalling contact	changeover contact
a.c. switching capacity	250 V / 0.5 A
d.c. switching capacity	250 V / 0.1 A; 125 V / 0.2 A; 75 V / 0.5 A
Cross-sectional area for remote signalling terminals	max. 1.5 mm ² solid / flexible
Extended technical data:	Use in switchgear installations with prospective short-circuit currents of more than 50 kA _{rms} (tested by the German VDE)
– Max. prospective short-circuit current	100 kA _{rms} (220 kA _{peak})
– Limitation / Extinction of mains follow currents	up to 100 kA _{rms} (220 kA _{peak})
– Max. backup fuse (L) up to $I_k = 100$ kA _{rms}	315 A gL/gG
Weight	1,36 kg
Customs tariff number	85363030
GTIN	4013364108165
PU	1 pc(s)

DEHNcombo

DCB YPV SCI 1000 FM (900 066)

- Prewired type 1 and type 2 combined lightning current and surge arrester for use in photovoltaic generator circuits
- Combined disconnection and short-circuiting device with safe electrical isolation prevents fire damage caused by d.c. switching arcs (patented SCI principle)
- Space-saving enclosure with a width of four modules



Figure without obligation

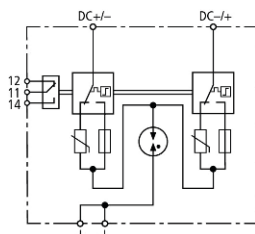

Basic circuit diagram DCB YPV SCI 1000 FM

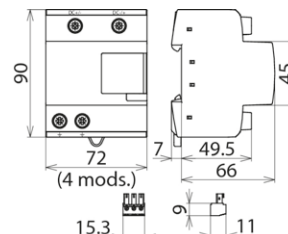

Dimension drawing DCB YPV SCI 1000 FM

Combined lightning current and surge arrester for use in photovoltaic power supply systems up to 1000 V d.c.; with floating remote signalling contact.

Type Part No.	DCB YPV SCI 1000 FM 900 066
SPD according to EN 50539-11	type 1 + type 2
Max. PV voltage [DC+ -> DC-] (U_{CPV})	≤ 1000 V
Max. PV voltage [DC+/DC- -> PE] (U_{CPV})	≤ 725 V
Short-circuit current rating (I_{SCPV})	1000 A
Nominal discharge current (8/20 μ s) (I_n)	15 kA
Total discharge current (8/20 μ s) [DC+/DC- -> PE] (I_{total})	30 kA
Total discharge current (10/350 μ s) [DC+/DC- -> PE] (I_{total})	12.5 kA
Specific energy [DC+/DC- -> PE] (I)	39.06 kJ/ohms
Lightning impulse current (10/350 μ s) [DC+ -> PE/DC- -> PE] (I_{imp})	6.25 kA
Specific energy [DC+ -> PE/DC- -> PE] (W/R)	9.76 kJ/ohms
Voltage protection level [(DC+/DC-) -> PE] (U_p)	2.5 kV
Voltage protection level [DC+ -> DC-] (U_p)	4.75 kV
Response time (t_A)	≤ 25 ns
Operating temperature range (T_U)	-40 °C ... +80 °C
Operating state / fault indication	green / red
Number of ports	1
Cross-sectional area (min.)	1,5 mm ² solid / flexible
Cross-sectional area (max.)	35 mm ² stranded / 25 mm ² flexible
For mounting on	35 mm DIN rails acc. to EN 60715
Enclosure material	thermoplastic, red, UL 94 V-0
Place of installation	indoor installation
Degree of protection	IP 20
Dimensions	4 module(s), DIN 43880
Approvals	KEMA
Type of remote signalling contact	changeover contact
a.c. switching capacity	250 V / 0.5 A
d.c. switching capacity	250 V / 0.1 A; 125 V / 0.2 A; 75 V / 0.5 A
Cross-sectional area for remote signalling terminals	max. 1.5 mm ² solid / flexible
Weight	437 g
Customs tariff number	85363030
GTIN	4013364153738
PU	1 pc(s)

DEHNshield

DSH TNS 255 (941 400)

- Application-optimised and prewired type 1 and type 2 spark-gap-based combined lightning current and surge arrester
- Space-saving arrester for compact and simply equipped electrical installations with reduced technical requirements
- Capable of protecting terminal equipment



Figure without obligation

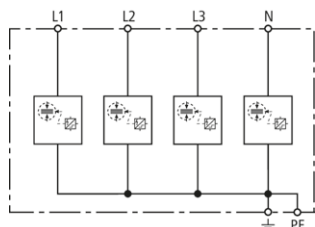

Basic circuit diagram DSH TNS 255

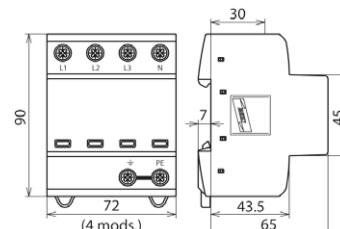

Dimension drawing DSH TNS 255

Application-optimised and prewired combined lightning current and surge arrester for TN-S systems.

Type	DSH TNS 255
Part No.	941 400
SPD according to EN 61643-11 / IEC 61643-11	type 1 + type 2 / class I + class II
Energy coordination with terminal equipment (≤ 5 m)	type 1 + type 2 + type 3
Nominal a.c. voltage (U_N)	230 / 400 V (50 / 60 Hz)
Max. continuous operating a.c. voltage (U_C)	255 (50 / 60 Hz)
Lightning impulse current (10/350 μ s) [L1+L2+L3+N-PE] (I_{total})	50 kA
Specific energy [L1+L2+L3+N-PE] (W/R)	625.00 kJ/ohms
Lightning impulse current (10/350 μ s) [L, N-PE] (I_{imp})	12.5 kA
Specific energy [L,N-PE] (W/R)	39.06 kJ/ohms
Nominal discharge current (8/20 μ s) [L/N-PE]/[L1+L2+L3+N-PE] (I_n)	12.5 / 50 kA
Voltage protection level [L-PE]/[N-PE] (U_P)	≤ 1.5 / ≤ 1.5 kV
Follow current extinguishing capability a.c. (I_{fi})	25 kA _{rms}
Follow current limitation / Selectivity	no tripping of a 32 A gL/gG fuse up to 25 kA _{rms} (prosp.)
Response time (t_A)	≤ 100 ns
Max. mains-side overcurrent protection	160 A gL/gG
Temporary overvoltage (TOV) [L-N] (U_T) – Characteristic	440 V / 120 min. – withstand
Operating temperature range (T_U)	-40 °C ... +80 °C
Operating state / fault indication	green / red
Number of ports	1
Cross-sectional area (L1, L2, L3, N, PE, \pm) (min.)	1.5 mm ² solid / flexible
Cross-sectional area (L1, L2, L3, N, PE, \pm) (max.)	35 mm ² stranded / 25 mm ² flexible
For mounting on	35 mm DIN rails acc. to EN 60715
Enclosure material	thermoplastic, red, UL 94 V-0
Place of installation	indoor installation
Degree of protection	IP 20
Capacity	4 module(s), DIN 43880
Approvals	KEMA, VDE, UL
Weight	525 g
Customs tariff number	85363030
GTIN	4013364133563
PU	1 pc(s)

DEHNcube

DCU YPV SCI 1000 1M (900 910)

- Prewired multipole surge arrester with IP 65 degree of protection for photovoltaic systems
- Combined disconnection and short-circuiting device with safe electrical isolation in the protection module prevents fire damage caused by d.c. switching arcs (patented SCI principle)
- Easy and fast implementation of surge protection measures since no space is required in a separate insulating enclosure



Figure without obligation

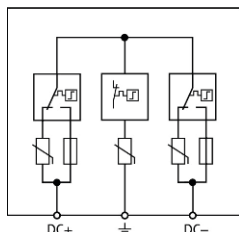

Basic circuit diagram DCU YPV SCI 1000 1M

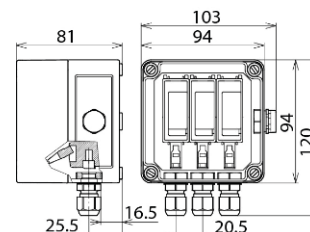

Dimension drawing DCU YPV SCI 1000 1M

Multipole surge arrester with three-step d.c. switching device for PV inverters with one MPP input.

Type	DCU YPV SCI 1000 1M
Part No.	900 910
SPD according to EN 50539-11	type 2
Max. PV voltage (U_{CPV})	≤ 1000 V
Short-circuit withstand capability (I_{SCPV})	1000 A
Total discharge current (8/20 μ s) (I_{total})	40 kA
Nominal discharge current (8/20 μ s) [(DC+/DC-) --> PE] (I_n)	12.5 kA
Max. discharge current (8/20 μ s) [(DC+/DC-) --> PE] (I_{max})	25 kA
Voltage protection level (U_p)	≤ 4 kV
Voltage protection level at 5 kA (U_p)	≤ 3.5 kV
Response time (t_A)	≤ 25 ns
Operating temperature range (T_U)	-35 °C ... +80 °C
Operating state / fault indication	green / red
Number of ports	1
Cross-sectional area (min.)	2.5 mm ² solid / flexible
Cross-sectional area (max.)	6 mm ² solid / flexible
Place of installation	outdoor
Degree of protection	IP 65
Type	with pressure compensating element
Cover	transparent cover with product label
Colour of enclosure	grey
Number of cable entries	3x \varnothing 3-7 mm
Enclosure dimensions (w x h x d)	94 x 94 x 81 mm
Approvals	KEMA
Weight	426 g
Customs tariff number	85363030
GTIN	4013364155046
PU	1 pc(s)

DEHNcube

DCU YPV SCI 1000 2M (900 920)

- Prewired multipole surge arrester with IP 65 degree of protection for photovoltaic systems
- Combined disconnection and short-circuiting device with safe electrical isolation in the protection module prevents fire damage caused by d.c. switching arcs (patented SCI principle)
- Easy and fast implementation of surge protection measures since no space is required in a separate insulating enclosure



Figure without obligation

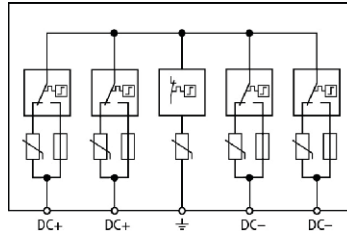

Basic circuit diagram DCU YPV SCI 1000 2M

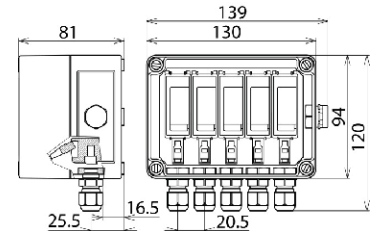

Dimension drawing DCU YPV SCI 1000 2M

Multipole surge arrester with three-step d.c. switching device for PV inverters with two MPP inputs.

Type	DCU YPV SCI 1000 2M
Part No.	900 920
SPD according to EN 50539-11	type 2
Max. PV voltage (U_{CPV})	≤ 1000 V
Short-circuit withstand capability (I_{SCPV})	1000 A
Total discharge current (8/20 μ s) (I_{total})	40 kA
Nominal discharge current (8/20 μ s) [(DC+/DC-) --> PE] (I_n)	12.5 kA
Max. discharge current (8/20 μ s) [(DC+/DC-) --> PE] (I_{max})	25 kA
Voltage protection level (U_p)	≤ 4 kV
Voltage protection level at 5 kA (U_p)	≤ 3.5 kV
Response time (t_A)	≤ 25 ns
Operating temperature range (T_U)	-35 °C ... +80 °C
Operating state / fault indication	green / red
Number of ports	1
Cross-sectional area (min.)	2.5 mm ² solid / flexible
Cross-sectional area (max.)	6 mm ² solid / flexible
Place of installation	outdoor
Degree of protection	IP 65
Type	with pressure compensating element
Cover	transparent cover with product label
Colour of enclosure	grey
Number of cable entries	5x \varnothing 3-7 mm
Enclosure dimensions (w x h x d)	130 x 94 x 81 mm
Approvals	KEMA
Weight	617 g
Customs tariff number	85363030
GTIN	4013364155053
PU	1 pc(s)

DEHNguard

DG M TNC CI 275 FM (952 309)

- Arrester backup fuse integrated in the protection module
- Prewired complete unit consisting of a base part and plug-in protection modules
- High reliability due to "Thermo Dynamic Control" SPD monitoring device



Figure without obligation

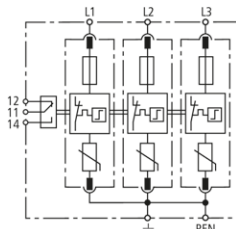

Basic circuit diagram DG M TNC CI 275 FM

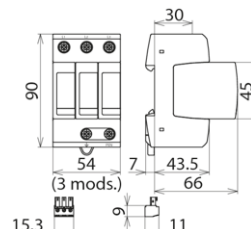

Dimension drawing DG M TNC CI 275 FM

Modular surge arrester with integrated backup fuses for TN-C systems.

Type	DG M TNC CI 275 FM
Part No.	952 309
SPD according to EN 61643-11 / IEC 61643-11	type 2 / class II
Nominal a.c. voltage (U_N)	230 / 400 V (50 / 60 Hz)
Max. continuous operating a.c. voltage (U_C)	275 V (50 / 60 Hz)
Nominal discharge current (8/20 μ s) (I_n)	12.5 kA
Max. discharge current (8/20 μ s) (I_{max})	25 kA
Voltage protection level (U_P)	≤ 1.5 kV
Voltage protection level at 5 kA (U_P)	≤ 1 kV
Response time (t_A)	≤ 25 ns
Max. mains-side overcurrent protection	not required
Rated breaking capacity of the internal backup protection	25 kA
Short-circuit withstand capability (I_{SCCR})	25 kA _{rms}
Temporary overvoltage (TOV) (U_T) – Characteristic	335 V / 5 sec. – withstand
Temporary overvoltage (TOV) (U_T) – Characteristic	440 V / 120 min. – safe failure
Operating temperature range (T_U)	-40 °C ... +80 °C
Operating state / fault indication	green / red
Number of ports	1
Cross-sectional area (min.)	1.5 mm ² solid / flexible
Cross-sectional area (max.)	35 mm ² stranded / 25 mm ² flexible
For mounting on	35 mm DIN rails acc. to EN 60715
Enclosure material	thermoplastic, red, UL 94 V-0
Place of installation	indoor installation
Degree of protection	IP 20
Capacity	3 module(s), DIN 43880
Approvals	KEMA, VDE
Type of remote signalling contact	changeover contact
a.c. switching capacity	250 V / 0.5 A
d.c. switching capacity	250 V / 0.1 A; 125 V / 0.2 A; 75 V / 0.5 A
Cross-sectional area for remote signalling terminals	max. 1.5 mm ² solid / flexible
Weight	382 g
Customs tariff number	85363030
GTIN	4013364128378
PU	1 pc(s)

DEHNguard

DG M TT CI 275 FM (952 327)

- Arrester backup fuse integrated in the protection module
- Prewired complete unit consisting of a base part and plug-in protection modules
- High reliability due to "Thermo Dynamic Control" SPD monitoring device



Figure without obligation

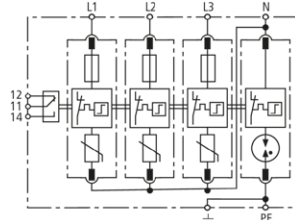

Basic circuit diagram DG M TT CI 275 FM

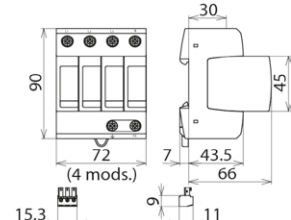

Dimension drawing DG M TT CI 275 FM

Modular surge arrester with integrated backup fuses for TT and TN-S systems ("3+1" circuits).

Type	DG M TT CI 275 FM
Part No.	952 327
SPD according to EN 61643-11 / IEC 61643-11	type 2 / class II
Nominal a.c. voltage (U_N)	230 / 400 V (50 / 60 Hz)
Max. continuous operating a.c. voltage [L-N] (U_C)	275 V (50 / 60 Hz)
Max. continuous operating a.c. voltage [N-PE] (U_C)	255 V (50 / 60 Hz)
Nominal discharge current (8/20 μ s) [L-N] (I_n)	12.5 kA
Nominal discharge current (8/20 μ s) [N-PE] (I_n)	20 kA
Max. discharge current (8/20 μ s) [L-N] (I_{max})	25 kA
Max. discharge current (8/20 μ s) [N-PE] (I_{max})	40 kA
Lightning impulse current (10/350 μ s) [N-PE] (I_{imp})	12 kA
Voltage protection level [L-N] (U_P)	≤ 1.5 kV
Voltage protection level [L-N] at 5 kA (U_P)	≤ 1 kV
Voltage protection level [N-PE] (U_P)	≤ 1.5 kV
Follow current extinguishing capability [N-PE] (I_E)	100 A _{rms}
Response time [L-N] (t_A)	≤ 25 ns
Response time [N-PE] (t_A)	≤ 100 ns
Max. mains-side overcurrent protection	not required
Rated breaking capacity of the internal backup protection	25 kA
Short-circuit withstand capability (I_{SCCR})	25 kA _{rms}
Temporary overvoltage (TOV) [L-N] (U_T) – Characteristic	335 V / 5 sec. – withstand
Temporary overvoltage (TOV) [L-N] (U_T) – Characteristic	440 V / 120 min. – safe failure
Temporary overvoltage (TOV) [N-PE] (U_T) – Characteristic	1200 V / 200 ms – withstand
Operating temperature range (T_U)	-40 °C ... +80 °C
Operating state / fault indication	green / red
Number of ports	1
Cross-sectional area (min.)	1.5 mm ² solid / flexible
Cross-sectional area (max.)	35 mm ² stranded / 25 mm ² flexible
For mounting on	35 mm DIN rails acc. to EN 60715
Enclosure material	thermoplastic, red, UL 94 V-0
Place of installation	indoor installation
Degree of protection	IP 20
Capacity	4 module(s), DIN 43880
Approvals	KEMA, VDE
Type of remote signalling contact	changeover contact
a.c. switching capacity	250 V / 0.5 A
d.c. switching capacity	250 V / 0.1 A; 125 V / 0.2 A; 75 V / 0.5 A
Cross-sectional area for remote signalling terminals	max. 1.5 mm ² solid / flexible
Weight	475 g
Customs tariff number	85363030
GTIN	4013364128392
PU	1 pc(s)

DEHNguard

DG M TNS 275 FM (952 405)

- Prewired complete unit consisting of a base part and plug-in protection modules
- High discharge capacity due to heavy-duty zinc oxide varistors / spark gaps
- High reliability due to "Thermo Dynamic Control" SPD monitoring device



Figure without obligation

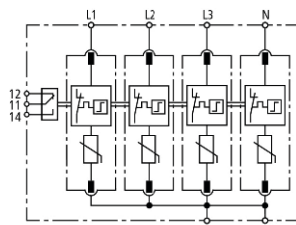

Basic circuit diagram DG M TNS 275 FM

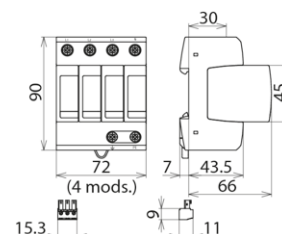

Dimension drawing DG M TNS 275 FM

Modular surge arrester for use in TN-S systems; with floating changeover contact.

Type	DG M TNS 275 FM
Part No.	952 405
SPD according to EN 61643-11 / IEC 61643-11	type 2 / class II
Nominal a.c. voltage (U_N)	230 / 400 V (50 / 60 Hz)
Max. continuous operating a.c. voltage (U_C)	275 V (50 / 60 Hz)
Nominal discharge current (8/20 μ s) (I_n)	20 kA
Max. discharge current (8/20 μ s) (I_{max})	40 kA
Voltage protection level (U_P)	≤ 1.5 kV
Voltage protection level at 5 kA (U_P)	≤ 1 kV
Response time (t_A)	≤ 25 ns
Max. mains-side overcurrent protection	125 A gG
Short-circuit withstand capability for max. mains-side overcurrent protection (I_{SCCR})	50 kA _{rms}
Temporary overvoltage (TOV) (U_T) – Characteristic	335 V / 5 sec. – withstand
Temporary overvoltage (TOV) (U_T) – Characteristic	440 V / 120 min. – safe failure
Operating temperature range (T_U)	-40 °C ... +80 °C
Operating state / fault indication	green / red
Number of ports	1
Cross-sectional area (min.)	1.5 mm ² solid / flexible
Cross-sectional area (max.)	35 mm ² stranded / 25 mm ² flexible
For mounting on	35 mm DIN rails acc. to EN 60715
Enclosure material	thermoplastic, red, UL 94 V-0
Place of installation	indoor installation
Degree of protection	IP 20
Capacity	4 module(s), DIN 43880
Approvals	KEMA, VDE, UL, VdS
Type of remote signalling contact	changeover contact
a.c. switching capacity	250 V / 0.5 A
d.c. switching capacity	250 V / 0.1 A; 125 V / 0.2 A; 75 V / 0.5 A
Cross-sectional area for remote signalling terminals	max. 1.5 mm ² solid / flexible
Weight	453 g
Customs tariff number	85363030
GTIN	4013364108462
PU	1 pc(s)

DEHNguard

DG M TNS CI 275 FM (952 406)

- Arrester backup fuse integrated in the protection module
- Prewired complete unit consisting of a base part and plug-in protection modules
- High reliability due to "Thermo Dynamic Control" SPD monitoring device



Figure without obligation

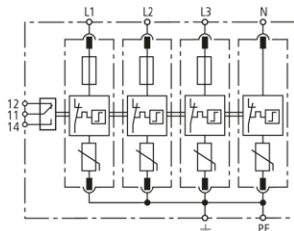

Basic circuit diagram DG M TNS CI 275 FM

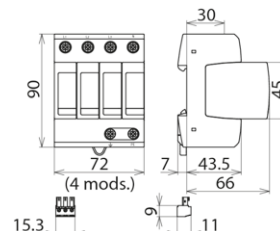

Dimension drawing DG M TNS CI 275 FM

Modular surge arrester with integrated backup fuses for TN-S systems.

Type	DG M TNS CI 275 FM
Part No.	952 406
SPD according to EN 61643-11 / IEC 61643-11	type 2 / class II
Nominal a.c. voltage (U_N)	230 / 400 V (50 / 60 Hz)
Max. continuous operating a.c. voltage (U_C)	275 V (50 / 60 Hz)
Nominal discharge current (8/20 μ s) (I_n)	12.5 kA
Max. discharge current (8/20 μ s) (I_{max})	25 kA
Voltage protection level (U_P)	≤ 1.5 kV
Voltage protection level at 5 kA (U_P)	≤ 1 kV
Response time (t_A)	≤ 25 ns
Max. mains-side overcurrent protection	not required
Rated breaking capacity of the internal backup protection	25 kA
Short-circuit withstand capability (I_{SCCR})	25 kA _{rms}
Temporary overvoltage (TOV) (U_T) – Characteristic	335 V / 5 sec. – withstand
Temporary overvoltage (TOV) (U_T) – Characteristic	440 V / 120 min. – safe failure
Operating temperature range (T_U)	-40 °C ... +80 °C
Operating state / fault indication	green / red
Number of ports	1
Cross-sectional area (min.)	1.5 mm ² solid / flexible
Cross-sectional area (max.)	35 mm ² stranded / 25 mm ² flexible
For mounting on	35 mm DIN rails acc. to EN 60715
Enclosure material	thermoplastic, red, UL 94 V-0
Place of installation	indoor installation
Degree of protection	IP 20
Capacity	4 module(s), DIN 43880
Approvals	KEMA, VDE
Type of remote signalling contact	changeover contact
a.c. switching capacity	250 V / 0.5 A
d.c. switching capacity	250 V / 0.1 A; 125 V / 0.2 A; 75 V / 0.5 A
Cross-sectional area for remote signalling terminals	max. 1.5 mm ² solid / flexible
Weight	473 g
Customs tariff number	85363030
GTIN	4013364128354
PU	1 pc(s)

DEHNguard

DG M YPV SCI 1000 FM (952 515)

- Prewired modular complete unit for use in photovoltaic systems consisting of a base part and plug-in protection modules
- Combined disconnection and short-circuiting device with safe electrical isolation in the protection module prevents fire damage caused by d.c. switching arcs (patented SCI principle)
- Safe replacement of protection modules without arc formation due to integrated d.c. fuses



Figure without obligation

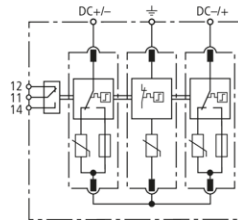

Basic circuit diagram DG M YPV SCI 1000 FM

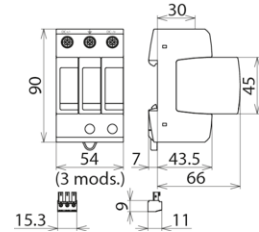

Dimension drawing DG M YPV SCI 1000 FM

Modular multipole surge arrester with three-step d.c. switching device for use in PV systems with remote signalling contact (floating changeover contact).

Type Part No.	DG M YPV SCI 1000 FM 952 515
SPD according to EN 50539-11	Type 2
Max. PV voltage (U_{CPV})	≤ 1000 V
Short-circuit current rating (I_{SCPV})	1000 A
Total discharge current (8/20 μ s) (I_{total})	40 kA
Nominal discharge current (8/20 μ s) [(DC+/DC-) \rightarrow PE] (I_n)	12.5 kA
Max. discharge current (8/20 μ s) [(DC+/DC-) \rightarrow PE] (I_{max})	25 kA
Voltage protection level (U_p)	≤ 4 kV
Voltage protection level at 5 kA (U_p)	≤ 3.5 kV
Response time (t_A)	≤ 25 ns
Operating temperature range (T_U)	-40 °C ... +80 °C
Operating state / fault indication	green / red
Number of ports	1
Cross-sectional area (min.)	1.5 mm ² solid / flexible
Cross-sectional area (max.)	35 mm ² stranded / 25 mm ² flexible
For mounting on	35 mm DIN rails acc. to EN 60715
Enclosure material	thermoplastic, red, UL 94 V-0
Place of installation	indoor installation
Degree of protection	IP 20
Capacity	3 module(s), DIN 43880
Approvals	KEMA, UL, CSA
Type of remote signalling contact	changeover contact
a.c. switching capacity	250 V / 0.5 A
d.c. switching capacity	250 V / 0.1 A; 125 V / 0.2 A; 75 V / 0.5 A
Cross-sectional area for remote signalling terminals	max. 1.5 mm ² solid / flexible
Weight	323 g
Customs tariff number	85363030
GTIN	4013364126435
PU	1 pc(s)

BLITZDUCTOR XTU

BXTU ML4 BD 0-180 (920 349)

- Universal voltage type with actiVsense technology
- For installation in conformity with the lightning protection zone concept at the boundaries from $0_A - 2$ and higher
- With integrated LifeCheck monitoring



Figure without obligation

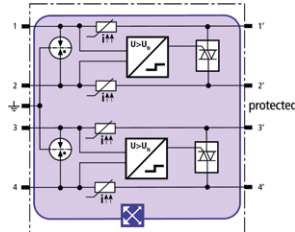

Basic circuit diagram BXTU ML4 BD 0-180

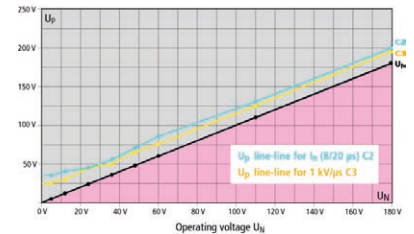

Diagram of the voltage protection level BXTU

Space-saving combined lightning current and surge arrester module with actiVsense and LifeCheck technology for protecting two pairs with the same or a different operating voltage of galvanically isolated balanced interfaces. Automatically detects the operating voltage of the useful signal and optimally adapts the voltage protection level to it.

Type Part No.	BXTU ML4 BD 0-180 920 349
SPD class	TYPE 1 Pt
SPD monitoring system	LifeCheck
Operating voltage (U_N)	0-180 V
Frequency of the operating voltage (f_{UN})	0-400 Hz
Max. continuous operating d.c. voltage (U_C)	180 V
Max. continuous operating a.c. voltage (U_C)	127 V
Permissible superimposed signal voltage (U_{signal})	$\leq \pm 5$ V
Cut-off frequency line-line (U_{signal} , balanced 100 ohms) (f_C)	50 MHz
Nominal current at 80 °C (equal to max. short-circuit current) (I_L)	100 mA
D1 Total lightning impulse current (10/350 μ s) (I_{imp})	10 kA
D1 Lightning impulse current (10/350 μ s) per line (I_{imp})	2.5 kA
C2 Total nominal discharge current (8/20 μ s) (I_n)	20 kA
C2 Nominal discharge current (8/20 μ s) per line (I_n)	10 kA
Voltage protection level line-line for I_n C2 (U_p)	see diagram, line C2
Voltage protection level line-line at 1 kV/ μ s C3 (U_p)	see diagram, line C3
Voltage protection level line-line for I_{imp} D1 (U_p)	$\leq U_N + 53$ V
Voltage protection level line-PG for C2/C3/D1	≤ 550 V
Series resistance per line	≤ 10 ohms; typically 7.5 ohms
Capacitance line-line (C)	≤ 80 pF
Capacitance line-PG (C)	≤ 16 pF
Operating temperature range (T_U)	-40 °C ... +80 °C
Degree of protection (plugged-in)	IP 20
Pluggable into	BXT BAS / BSP BAS 4 base part
Earthing via	BXT BAS / BSP BAS 4 base part
Enclosure material	polyamide PA 6.6
Colour	yellow
Test standards	IEC 61643-21 / EN 61643-21, UL 497B
SIL classification	up to SIL3 ^{*)}
Approvals	CSA, UL, GOST
Weight	25 g
Customs tariff number	85363010
GTIN	4013364126404
PU	1 pc(s)

^{*)} For more detailed information, please visit www.dehn-international.com.

BLITZDUCTOR

BXT BAS (920 300)

- Four-pole version for universal use with all types of BSP and BXT / BXTU protection modules
- No signal interruption if the protection module is removed
- Universal design without protection elements



Figure without obligation

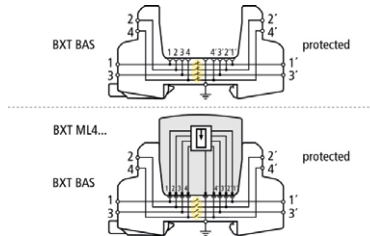

Basic circuit diagram with and without plugged-in module

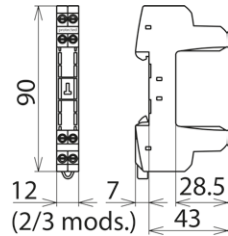

Dimension drawing BXT BAS

The BLITZDUCTOR XT base part is a very space-saving and universal four-pole feed-through terminal for the insertion of a protection module without signal interruption if the protection module is removed. The snap-in mechanism at the supporting foot of the base part allows the protection module to be safely earthed via the DIN rail. Since no components of the protective circuit are situated in the base part, only the protection modules must be maintained.

Type Part No.	BXT BAS 920 300
Operating temperature range (T _U)	-40 °C ... +80 °C
Degree of protection	IP 20
For mounting on	35 mm DIN rails acc. to EN 60715
Connection (input / output)	screw / screw
Signal disconnection	no
Cross-sectional area, solid	0.08-4 mm ²
Cross-sectional area, flexible	0.08-2.5 mm ²
Tightening torque (terminals)	0.4 Nm
Earthing via	35 mm DIN rails acc. to EN 60715
Enclosure material	polyamide PA 6.6
Colour	yellow
ATEX approvals	DEKRA 11ATEX0089 X: II 3 G Ex nA IIC T4 Gc ^{*)}
IECEx approvals	DEK 11.0032X: Ex nA IIC T4 Gc ^{*)}
Approvals	CSA, VdS, UL, GOST
Weight	34 g
Customs tariff number	85369010
GTIN	4013364109179
PU	1 pc(s)

^{*)} only in connection with an approved protection module

Air-termination rod

FS 10 1000 AL (101 000)



Figure without obligation

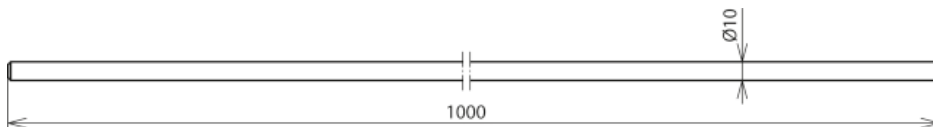

Air-termination rod chamfered on both sides, for protecting roof-mounted structures, chimneys etc., also for erection with concrete base (8.5 kg) for wedge mounting or for fixing with rod holders / spacers.

Part No.	101 000
Total length (l1)	1000 mm
Material	Al
Diameter Ø	10 mm
Standard	EN 62561-2
Weight	212 g
Customs tariff number	85389099
GTIN	4013364094505
PU	20 pc(s)

Concrete base

BES 8.5KG KT10 16 D240 SET (102 075)



Figure without obligation

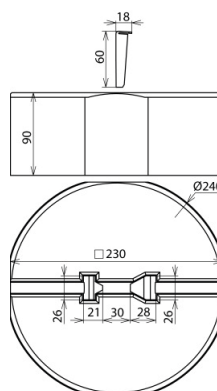

Concrete bases for air-termination rods Ø 10 mm (length 1000 mm), protecting small-sized roof-mounted structures on flat roofs and for installing spacers, e.g. for isolated ring conductors with DEHNiso spacers Ø 16 mm, length up to 675 mm (distance 0.8 m).

Part No.	102 075
Type	stackable
Support	wedge mounting Ø10 / 16 mm
Diameter Ø	240 mm
Material	concrete (C45/55)
Material of wedge	StSt
Weight	8,46 kg
Customs tariff number	85389099
GTIN	4013364094215
PU	120 pc(s)

Earthing clamp

UEK 8.10 AQ4 50 HKSM8 V2A (540 250)



Figure without obligation

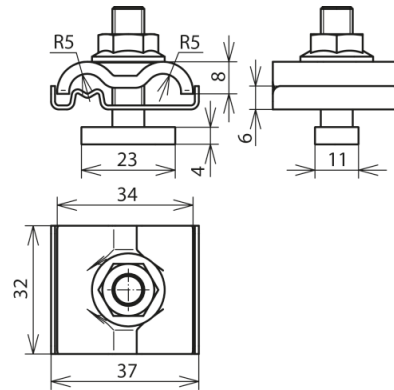

Earthing clamps for integrating mounting systems e.g. of PV installations into the functional equipotential bonding/functional earthing (optionally black conductor) and lightning equipotential bonding according to IEC/EN 62305-3.

The StSt contact plate (intermediate element) allows for different materials of conductors (Cu, Al, St/tZn and StSt) to be connected to the usual mounting systems, e.g. to aluminium, without the risk of contact corrosion.

The double cleat design allows for easy and quick interconnection of the profiles, e.g. by feed-through wiring.

Part No.	540 250
Material of clamp	StSt
Clamping range Rd	8-10 mm
Connection (solid / stranded)	4-50 mm ²
Screw	hammer-head bolt M8 x 30 mm
Self-locking nut	width across flats 13 mm
Material of screw / nut	StSt
Standard	EN 62561-1
Weight	60 g
Customs tariff number	85389099
GTIN	4013364138650
PU	50 pc(s)

www.dehn-international.com/partners



Surge Protection
Lightning Protection
Safety Equipment
DEHN protects.

DEHN + SÖHNE
GmbH + Co.KG.

Hans-Dehn-Str. 1
Postfach 1640
92306 Neumarkt
Germany

Tel. +49 9181 906-0
Fax +49 9181 906-1100
info@dehn.de
www.dehn-international.com



www.dehn-international.com/partners

Type designations of products mentioned in the white paper being at the same time registered trademarks are not especially marked. So if there is no marking of TM or © this does not mean that the type designation is a free trade name. Neither it can be seen whether patents or utility models and other intellectual and industrial property rights are available. We reserve the right to introduce changes in performance, configuration and technology, dimensions, weights and materials in the course of technical progress. The figures are shown without obligation. Misprints, errors and modifications excepted. Reproduction in any form whatsoever is forbidden without our authorisation.

actiVsense, BLITZDUCTOR, BLITZPLANER, DEHN, DEHN Logo, DEHN schützt, DEHNbloc, DEHNfix, DEHNgrip, DEHNguard, DEHNport, DEHNQUICK, DEHNrapid, DEHNshield, DEHNSnap, DEHNventil, HVI, LifeCheck, Red/Line are protected by German Trade Mark, by Community Trade Mark (EU) and/or in other countries.