



DEHNrecord SD

Multifunctional measuring and analysis device
for monitoring power quality

Manual

Manufacturer

DEHN SE
Hans-Dehn-Str. 1
92306 Neumarkt
Germany

Tel. +49 9181 906-0

www.dehn-international.com

Technical Support Service Hotline

Tel. +49 9181 906-1750

itss@dehn.de

Legal notice	2
Manufacturer	2
Technical Support Service Hotline	2
1. Terms and abbreviations	6
2. Safety	7
2.1 Normal use	7
3. Delivery includes	8
3.1 Accessories (optional)	8
4. Specification	9
4.1 Power quality measurement according to EN 61000-4-30, class A	10
4.2 Additional measurement capabilities	10
4.3 Device variants	11
4.4 Measurement locations, measurement tasks	11
4.5 Measured values – recording	12
4.6 Measured values – Evaluation of power quality (PQ)	13
4.7 Measurement site concept	14
4.8 Configuration	16
4.9 Events and output channels	17
5. Device description	18
6. Mounting	20
6.1 Mounting as a single device	20
6.2 Mounting with surge protective device and busbar	21
6.3 Use in overvoltage category IV	22

7.	Connection	24
7.1	Connection DRC SD 1 1 – Part No. 910 920	24
7.2	Connection DRC SD 2 1 – Part No. 910 921	25
7.3	DRC SD ICS 100 impulse current sensor (Part No. 910 935)	26
7.4	Current sensors	27
8	Commissioning	28
8.1	Step 1 – Applying the voltage	28
8.2	Step 2 – Connection to the web server	28
8.3	Step 3 – Check	28
8.4	Step 4 – Configuration	29
9.	Functionality	30
9.1	User interface	30
9.2	Block diagram	32
9.3	Measured values	33
9.4	Modbus	35
9.5	Communication via the network	36
9.6	Firmware update	37
10.	Device settings	38
10.1	Device settings expert mode	38
10.2	General	38
10.3	LED indicator	38
10.4	Digital inputs, digital outputs and logic	39
10.5	Network	43
10.6	Power frequency overvoltage as per EN 50550 - POP	45
10.7	Current measurement	47
10.8	Mains signalling voltages	49
10.9	Factory reset	49

11. PQ Configuration	50
11.1 General	50
11.2 Voltage magnitude	50
11.3 Frequency	51
11.4 Flicker	51
11.5 Voltage dip, voltage swell, voltage interruption	52
11.6 Voltage dip	52
11.7 Voltage swell	52
11.8 Voltage interruption	53
11.9 Unbalance	53
11.10 Total harmonic distortion THD, harmonics, interharmonics	54
11.11 Mains signalling voltages	54
11.12 Rapid voltage changes	55
11.13 Values for PQ characteristics	56
12. Technical data	59
13. Maintenance	71
13.1 Check	71
13.2 Cleaning	72
13.3 Dismantling	72
13.4 Disposal	72

PQ	Power Quality
DRC SD	DEHNrecord SD
SP	Surge protection
SPD	Surge Protective Device
POP	Power frequency overvoltage protective device
UTC	Coordinated Universal Time
MSRL	Equipment for measurement, control, and laboratory use according to EN 61010-1
PLC	Programmable logic controller

2. Safety



WARNING

Risk of electric shock



IEC 60417-6182:
Installation,
electrotechnical expertise

Mounting and connection of a DEHNrecord SD may only be carried out by a qualified electrician in accordance with the installation standards of the country.

Before mounting, check the DEHNrecord SD (DRC SD) and the accessories for external damage.

If any damage or other defect is detected, do not mount the DRC SD.

Loads exceeding the specified values may destroy the DRC SD and the electrical equipment connected to it.

Tampering with and modifying the DRC SD will void the warranty.

If the DRC SD is used together with a surge protective device (SPD) in environments with overvoltage category IV, make sure that the SPD is functional before accessing the device.

If the SPD indicates a defect, the SPD must first be repaired before the DRC SD can be accessed.

The installation instructions for the SPD must be observed for this purpose.

2.1 Intended use

The DRC SD is permitted for use in the control cabinet and only within the conditions specified in this manual.

If the device is used in a manner not specified, the protection supported by the device may be impaired.

Only approved accessories may be used.

An external time signal from a time server is required for synchronization (see chapter 9.5 Communication via the network)

3. Scope of delivery

DEHNrecord SD
 Connector IO
 Connector CM
 Installation instructions

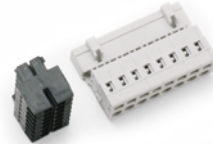

3.1 Accessories (optional)

Impulse current sensor DRC SD ICS 100, Part No. 910 935
 Split core current sensors DRC SD SCS 100,1 m, Part No. 910 936
 Rogowski coils DRC SD RCS 1000, 3 m, Part No. 910 937
 Rogowski coils DRC SD RCS 1000, 1 m, Part No. 910 938
 Busbar (suitable for surge protective device)
 for use in combination with a surge protective device (SPD)



Impulse current sensor DRC SD ICS 100

Schematic overview of functions

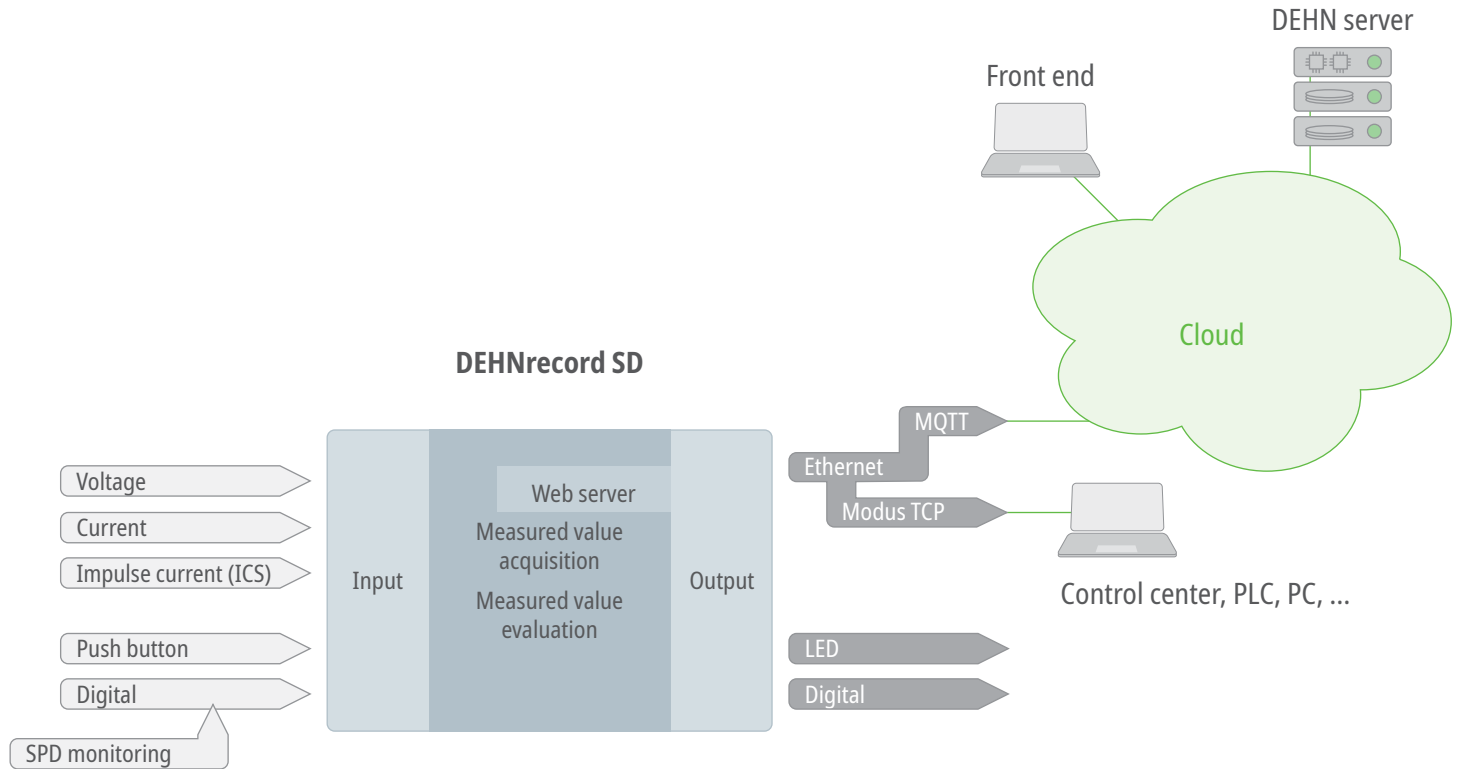

4. Service description

4.1 Measuring the power quality according to EN 61000-4-30, class A

Monitored are: Voltage magnitude, frequency, flicker, voltage dips, voltage swells, interruption, unbalance, harmonics, interharmonics, mains signalling voltages, rapid voltage changes.

Measurement/recording	Analysis and evaluation
Power quality according to EN 61000-4-30:2015, class A	According to standard EN 50160 and at the same time according to individual specifications

4.2 Additional measurement capabilities

Measurement/recording	Analysis and evaluation
Impulse current 8/20 μ s and 10/350 μ s to 100 kA	By maximum, duration, rise time, and single/sum charge.
Current, power, energy via up to 4 current sensors (Rogowski coils or split core current transformers)	Limit values for current, power (P, Q, S), current direction, zero current and energy (global) can be parameterized separately for each phase or the neutral conductor
Power frequency overvoltages (POP)	According to standard EN 50550 and also individually with differentiation exceedance/undershot
Digital states at 3 inputs	According to state/change with counter function. The inputs can be logically linked to one another and to other device functions.

4. Service description

4.3 Device variants

DRC SD 1 1 (Part No. 910 920)	Power supply 230 volts via L1 of the measuring voltage. The device can bridge supply interruptions for up to 5 seconds.
DRC SD 2 1 (Part No. 910 921)	Power supply 24 volts DC external. Records interruptions and voltage dips even over 5 seconds in accordance with EN 61000-4-30, class A if the external power supply is uninterruptible.

4.4 Measurement locations, measurement tasks

Utilities

Power quality (monitoring, evaluation)
energy consumption, load profile

Energy consumer

Energy measurement and monitoring
Power quality (monitoring, analysis)

Installation point

Local network stations, cable distribution cabinets,
measuring transducer cabinets, transfer points to customer facility, main distributions, sub-distributions, terminal device level.
For a normative evaluation of the power quality according to EN 50160, the preferred installation location is the transfer point from supplier to consumer.

4. Service description

4.5 Measured values – recording

Cyclic measurement (SoL – sign-of-life-data)

Measured values are transmitted cyclically to the cloud and are available there for graphical display in the grid of observation periods (1 week).

For evaluation and transmission, the measured values are calculated to 5-minute intervals (current, power, energy) or 10-minute intervals (PQ) UTC time-synchronously.

Event-based

An event is generated when a parameterized limit value is violated. The device transfers the determined characteristic values and detailed event data to the cloud.

This reduces the scope of measured values obtained to the relevant data.

This can be done from all measurement functions. In conjunction with the high-resolution temporal detailed data, this function provides a detailed fault record.

Events can also be assigned to different output channels:

LED, digital output, e-mail.

Events are categorized by basic device functions (device, PQ, impulse current, ...) and their sub-functions – e.g. for PQ: voltage magnitude, frequency, unbalance.

User-controlled

The user can start a fast data transfer by pressing a button on the device or via the cloud.

The 3-second average values are continuously sent to the cloud over a period of 10 minutes.

This enables a detailed insight into the current status quo.

4. Service description

4.6 Measured values – evaluation of power quality (PQ)

Standard parameter set

To ensure that the results obtained in the field of public electricity supply networks are comparable, the limit values according to EN 50160 are applied. These cannot be changed by the user.

PQ overview

If the device is registered in DEHNmonitor PQ (DEHN's cloud), the results of the standard analysis are visible for all users in the cloud. The positions of the devices are generalized.

Individual parameter set

In parallel, it is possible to monitor user or site-specific issues at the same time. The limit values for event detection can be specified individually for this purpose.

The start of application of an individual parameter set can also be defined (immediately or by date). This allows a parameter set to be set specifically for an observation period.

Example: A desired target corridor for the voltage characteristics can be monitored

Example: Monitoring for an industrial environment according to the specifications of the IEC 61000-2-4 standard

4. Service description

4.7 Measurement site concept

Measurement site

The measurement site concept is only available in DEHN's cloud, the DEHNmonitor PQ. Each device is assigned to a virtual measurement site in the DEHNmonitor PQ via its serial number from the time of manufacture. The DEHNrecord SD is configured via the measurement site and returns data to the measurement site.

The virtual measurement sites have a name and can be configured individually. The user can manage "his" devices via his own measurement sites (name, position, ...).

When a DEHNrecord SD is replaced, the "historical" data is retained in the measurement site. Via the serial number, a new/different device can be assigned to the measurement site again.

Measurement sites can also be shared with other users/organizations. Registration in the cloud is required.

Measurement site type

A measurement site type defines a specific configuration (parameters, limit values, output channels) that can be assigned to several DRC SD.

Example: The measurement site type "IT customer" evaluates special parameters that are relevant for data centres.

Changes to the measurement site type are automatically transferred to all measurement sites with the corresponding measurement site type.

Measurement site node

Measurement sites can be grouped. This allows e.g. common evaluations. Within the groups, the measurement site types can be different and, for example, evaluate different limit values for the current.

Example: All measurement sites of the city "Augsburg" are grouped. This enables a regional evaluation of e.g. 100 measurement sites.

Principle of the measurement site concept

Measurement sites of the same measurement site type behave in the same way and can be parameterized easily and with little effort via the cloud. This is a key benefit for managing many devices.

This concept is available in DEHNmonitor PQ.

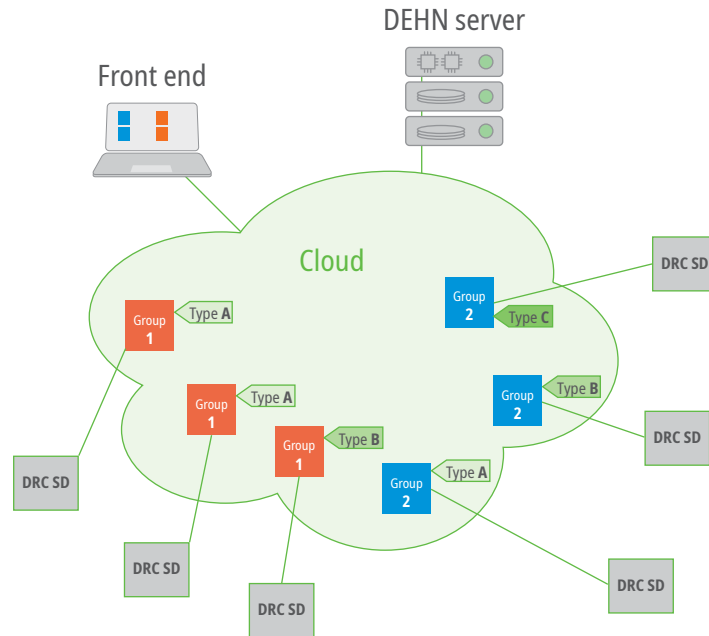

4. Service description

4.8 Configuration

Web server

The basic settings can be entered via the internal web server:

Location, assignment and type of external coils/transducers for current measurement, parameters of the mains signalling voltage.

More detailed explanations of the device settings can be found in chapter 10.4.

Modbus TCP

Device access via Ethernet interface enables access to parameters, limit values, current, cyclical data/statuses and event data.

Cloud access

The device can be configured via the DEHNmonitor PQ. You have access to the current, cyclic and past data/status/event data including detailed histories.

At present, the DEHNmonitor PQ is still in test mode.

4. Service description

4.9 Events and output channels

Events

Events are generated by:

- Evaluation of measured values (every exceeding of a limit value of all measurement functions generates an event)
- Digital input
- Keystroke
- Command from the cloud
- The device itself

Example: voltage measurement, exceeding a limit value

Example: digital input, SPD monitoring

Example: briefly press button 2 → Start web server, LED 1 (device) lights up blue.

Example: device update → “Firmware update successful” is reported to the cloud

Output channels

There are three output channels:

- Ethernet (Cloud, Modbus TCP)
- LED
- Digital output

The e-mail notification is provided via the cloud (DEHNmonitor PQ)

Example: connection establishment cloud → LED 1 (device) green

Example: SPD monitoring, a digital input triggers an e-mail at the measurement site and switches LED 2 (status) to red/yellow

5. Device description

Cross-sectional area: 1.5 - 6 mm² fine-stranded/stranded wire
 1.5 - 10 mm² solid wire

Stripping length: 16 mm

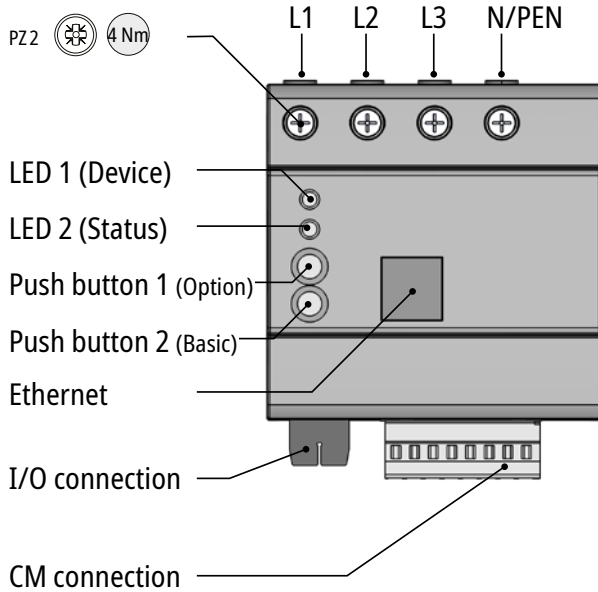

Attention! Current sensors must be connected to the device **before** mounting on the current conductor!

A slotted screwdriver (≤ 2.5 mm) is required to unlock the push-in connectors

Description	Function
L1	Measurement input and power supply for model DRCSD 1 ...
(L1), L2, L3, N	Measurement input
LED 1 (Device)	Green (flashing): Start Green (lights up): Cloud connection active Blue: Web server active Yellow: Action 1 active Red: Action 2 active (RGB LED, active status messages are displayed consecutively)
LED 2 (Status)	Lights up green: Power quality OK (in factory setting) (RGB-LED, configurable, can be assigned to other device functions)
Push button 1 (Option)	Short (< 1 s): Action 1: Start fast data transfer Long (> 5 s): Action 2: Device stop/start Long (>10 sec): Factory reset
Push button 2 (Basic)	Short (< 1 s): Activate web server Long (> 5 s): Device reset
Ethernet	Network connection: Connection to internal web server, Modbus TCP, cloud
I/O connection	Connections for impulse current sensor, int./ext. power supply, digital inputs and outputs
CM connection	Connections for current sensors

5. Device description (plug)

I/O connection (input, output, supply, impulse coil)

Description		Terminal		
Impulse current sensor	Imp2	2	1	Imp1
24 Volt version (model DRCSD 2 ...) Ext. power supply +24 V _{DC}	Ue-	4	3	Ue+ (+24 V in)
230 Volt version (Model DRCSD 1 ...) Auxiliary voltage, output +12 V _{DC} , - exclusively for the operation of the potential-free digital inputs				Ue+ (+12 V out)

Cable length maximum 30 m	-	Observe polarity!	+	
Input 1: max. 30 V _{DC}	I1.2	6	5	I1.1
Input 2: max. 30 V _{DC}	I2.2	8	7	I2.1
Input 3: max. 30 V _{DC}	I3.2	10	9	I3.1

Cable length maximum 30 m	Polarity does not matter			
Output 1 (potential-free contact) max. 30 V, max. 500 mA	O1.2	12	11	O1.1
Output 2 (potential-free contact) max. 30 V, max. 500 mA	O2.2	14	13	O2.1

Cross-sectional area plug I/O (push-in):
 0.08 - 1.5 mm² solid-wire, fine-stranded-wire
 0.25 -1.0 mm² with ferrule
 Stripping length: 6 ... 7 mm

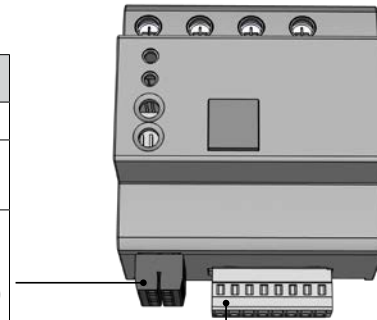

A slotted screwdriver (≤ 2.5 mm) is required to unlock the push-in connectors

CM connection (current sensors)

Terminal	1	2	3	4	5	6	7	8
Description	IL1.1	IL1.2	IL2.1	IL2.2	IL3.1	IL3.2	IN.1	IN.2
Current sensor	L1		L2		L3		N	

Cross-sectional area plug CM (push-in):
 0.08 - 2.5 mm² solid-wire, fine-stranded-wire
 0.25 -1.5 mm² with ferrule
 Stripping length: 8 ... 9 mm

6. Mounting

6.1 Mounting as a single device

The device is mounted on a 35 mm DIN rail according to EN 60715.
Use in areas with overvoltage category III.

Backup fuse

The backup fuse must be selected to match the connection line, e.g. for 1.5 mm² → B 16 A



6. Mounting

6.2 Mounting with surge protective device and busbar

This combination is, among other things, for use in areas with overvoltage category IV.

Suitable busbars are available for connection to a surge protective device (SPD).

For more information, see the following chapter "Use with overvoltage category IV".

Installation and connection of a DEHNrecord SD as well as possible through-wiring via its connection terminals may only be carried out by a qualified electrician in accordance with the installation standards of the country.

Backup fuse

The specifications of the respective SPD must be observed.

Through-wiring

In the case of through-wiring via the terminals of the DRC, the backup fuse must be selected accordingly.

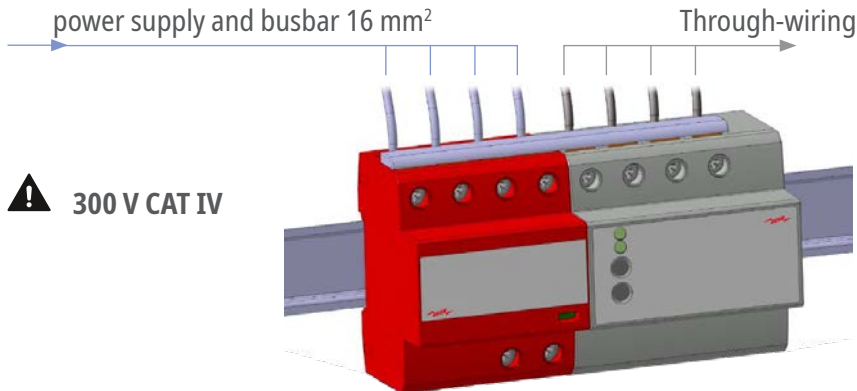

The latching elements of the devices have a permanent release position to facilitate joint mounting/removal on the DIN rail.

6. Mounting

6.3 Use with overvoltage category IV

Basically, the current and voltage measuring inputs of the DEHNrecord SD are designed for measuring category 300 V CAT III according to EN 61010-2-030. This measurement category includes corresponding test levels (4 kV) for overvoltage category III at 300 V according to EN 60664.

If the DEHNrecord SD is located in the protected area of a surge protective device (SPD), it can also be used in overvoltage category IV. The SPD must limit the overvoltages to a level below 2.5 kV.

The SPD must have an optical defect indicator and should be in the same field of view as the DEHNrecord SD.

Within the protection range of the SPD, the measurement category 300 V CAT III is achieved for the current and voltage measurement inputs of the DEHNrecord SD.

The safety instructions from chapter 2 must be observed!

It is recommended to monitor the functionality of the lightning current arresters and surge arresters used (e.g. DEHNventil, DEHNvenCi, DEHNshield, DEHNvap, DEHNguard, etc.).

See the example monitoring of the FM contact on the following pages in chapter 7.1 and 7.2.

Current measurement with DRC SD SCS 100 split core current sensors (Part No. 910 936) under CAT IV conditions:

These can be used if the protection of the SPD also applies to the current conductors on which measurements are made.

Current measurement with DRC SD RCS 1000 Rogowski coils (Part No. 910 937 / 910 938) under CAT IV conditions:

These can be used up to 600 V CAT IV.

The protection of the SPD does not necessarily apply to the current conductors on which measurements are made.

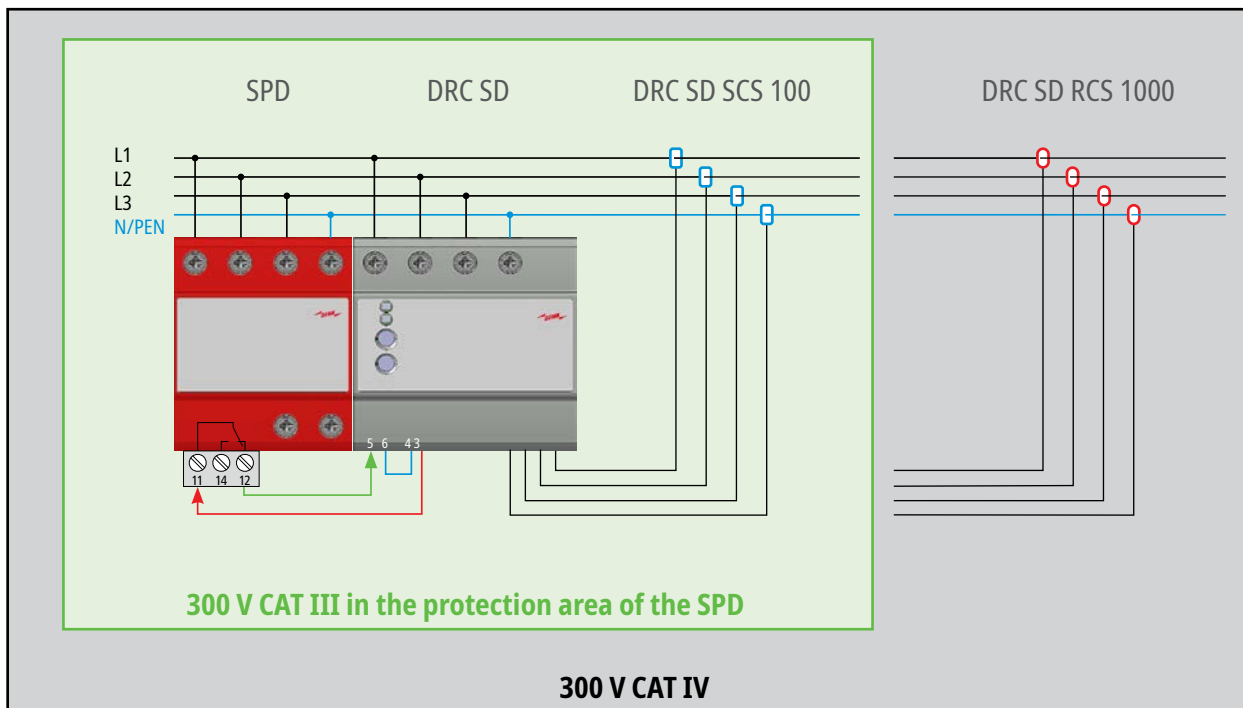

Example:

Installation of the DEHNrecord SD with an SPD in an environment with overvoltage category IV.

In the protection area of the SPD (green area), the measurement category 300 V CAT III required for the DEHNrecord SD is achieved.

At the same time, the DEHNrecord SD monitors the functionality of the SPD via its remote signalling contact.

Current measurement is optionally possible with split core current sensors (DRC SD SCS 100) or Rogowski coils (DRC SD RCS 1000).

7. Connection

7.1 Connection DRC SD 1 1 – Part No. 910 920



Measurement inputs

L1, L2, L3 and N are connected with cables or a suitable busbar.

Power supply

The device is supplied via the measuring input L1 and N and can bridge supply interruptions of up to 5 s.

In the event of longer interruptions, the data is recorded with reduced accuracy.

Power supply U_B : 230 V_{AC} (50 Hz), max. 30 mA

Digital inputs and outputs

The status of an SPD, for example, can also be monitored via an input. An event can be signaled via an output channel (LED, digital output, e-mail).

Auxiliary voltage

The auxiliary voltage (U_{e+} , U_{e-}) is used to operate the potential-free digital inputs.

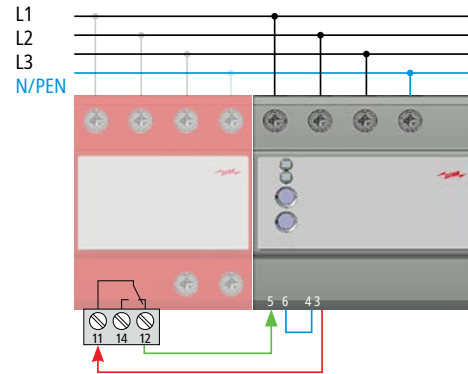

Example wiring of an SPD with remote signalling contact:

- Connect SPD contact (connection 11) with auxiliary voltage 12 V_{DC} (plug I/O terminal 3)
- Feedback from SPD contact (connection 12 or 14) to digital input I1.1 (plug I/O terminal 5)
- Earth connection (plug I/O terminals 4 and 6)

Configuration via the DRC web server:

The digital input is assigned to an output channel. If the contact of the SPD opens, e.g. information is sent by e-mail, an LED is switched or a digital output is activated.

7. Connection

7.2 Connection DRC SD 2 1 – Part No. 910 921



Measurement inputs

L1, L2, L3 and N are connected with cables or a suitable busbar.

24 V_{DC} external power supply

The DRC is supplied via an uninterruptible, external voltage source. This means that voltage interruptions and dips > 5 s can also be recorded in accordance with EN 61000-4-30, Class A.

Digital inputs and outputs

The status of an SPD, for example, can also be monitored via an input. An event can be signalled via an output channel (LED, digital output, e-mail).

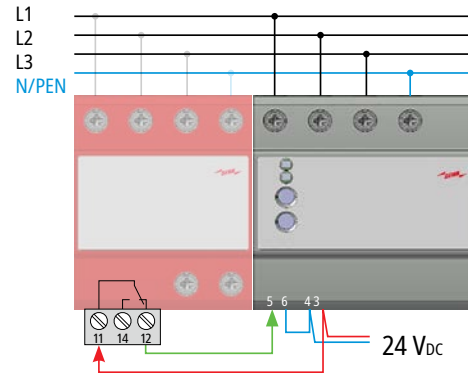

Example wiring of an SPD with remote signalling contact:

- Connect SPD contact (connection 11) with supply voltage 24 V_{DC} (plug I/O tmnl 3)
- Feedback from SPD contact (connection 12 or 14) to digital input I1.1 (plug I/O tmnl 5)
- Earth connection (plug I/O tmnl 4 and 6)

Configuration via the DRC web server:

The digital input is assigned to an output channel. If the contact of the SPD closes, e.g. information is sent by e-mail, an LED is switched or a digital output is activated.

7. Connection

7.3 Impulse current sensor DRC SD ICS 100 (Part No. 910 935)

With the optionally available impulse current sensor, impulse currents of up to 100 kA (8/20 μ s, 10/350 μ s) can be recorded on **insulated** conductors. Typical mounting locations are earthing connections of surge protective devices, equipment and lightning protection components. The sensor must be activated via the web server or the cloud. Further settings such as the trigger threshold can then also be configured.

Connection on the device

The sensor is connected to the DEHNrecord SD, Connection I/O:

brown wire → terminal 1 = Imp1

white wire → terminal 2 = Imp2

Maximum connecting cable sheath thickness: 5 mm

Mounting the sensor

The impulse current sensor must be connected to the terminal block (I/O connection) and plugged into DEHNrecord SD before it is mounted on the insulated conductor.

The sensor can be fixed to the current path to be monitored with two cable ties. The arrow indicates the positive impulse current direction. To prevent interference from adjacent cables, measurements should be performed on individually routed conductors.

Installation may only be carried out on insulated conductors which are not dangerously live.

Test and configuration

The connection of the impulse current sensor can be configured via the internal web server of the DEHNrecord SD or the cloud.

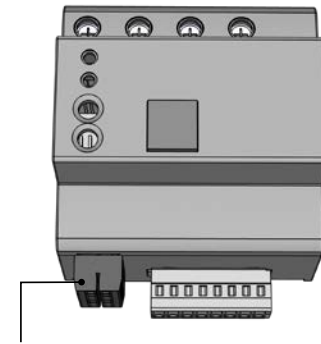
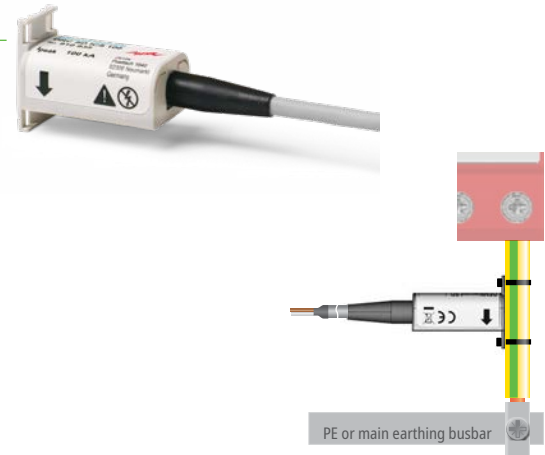

I/O connection

7. Connection

7.4 Current sensors

With the flexible Rogowski coil current sensors (DRC SD RCS 1000, 3m, Part No. 910 937) or split core current transformers (DRC SD SCS 100, 1m, Part No. 910 938) available as accessories, up to 4 power-frequency load currents can be recorded per device. From this, power values and energy values are calculated.

The use is to be parameterized via the web server and can be configured individually.

Connection on the device

- Step 1: Disconnect the system before mounting it on uninsulated, live, active conductors.
- Step 2: Connect the current sensors to the terminal block and plug in the terminal block.
- Step 3: Mount current sensors on the conductor.

Dismantling

- Step 1: Disconnect the system before dismantling on uninsulated, live, active conductors.
- Step 2: Dismantle the current sensors from the conductor.
- Step 3: Disconnect the current sensors from the terminal block

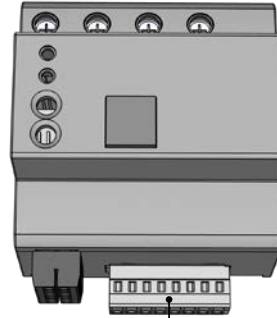

CM connection (current sensors)

Terminal	1	2	3	4	5	6	7	8
Description	IL1.1	IL1.2	IL2.1	IL2.2	IL3.1	IL3.2	IN.1	IN.2
Current sensor	L1		L2		L3		N	

8. Commissioning

8.1 Step 1 – Applying the voltage

After applying the voltage: LED 1 (Device) flashes green when the power supply is correct
LED 2 (Status) lights up green when the power quality is good (in factory configuration)

8.2 Step 2 – Connection to the web server

Connect DEHNrecord SD directly to computer:

1. Configure computer: IP 169.254.0.1, Sub. 255.255.255.0
2. Connect computer and DEHNrecord SD directly with network cable
3. Activate web server: press push button 2 (Basic) briefly,
LED 1 (Device) lights up blue
4. Access with browser: <http://169.254.0.10>
Password in delivery state: **smartdevice**

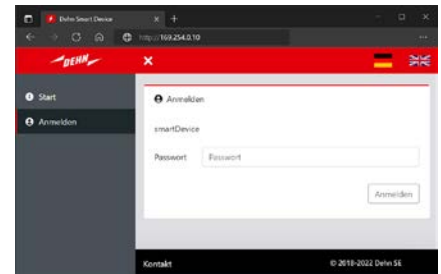

8.3 Step 3 – Check

After successful login, the following properties can be checked and settings can be made, for example:
Rotation field direction of the voltage connections, connection of the current measuring coils, connection of the impulse current sensor.

8. Commissioning

8.4 Step 4 – Configuration

The DEHNrecord SD can be configured appropriately via the web server.

Instructions for device settings can be found in chapter 10.

Access to the cloud server is preconfigured (MQTT, port 8883).

LED 1 (Device) lights up permanently green as soon as access to the DEHNmonitor PQ is working.

Product registration

For successful product registration at DEHNmonitor PQ (www.dehn.de/powerquality-monitor), the four digits after the serial number are required in addition to the serial number.

These are only printed on the DEHNrecord SD itself!

Example: "0000" in "FHA12345678-0000"









9. Functionality

9.1 User interface

User interface – LEDs

The display on the device is by means of two RGB LEDs. These also differ by flashing or lighting up permanently. Simultaneously active operating states are indicated by LED 1 (Device) one after the other.

Display with standard configuration

LED 1 (Device)		blue	web server active
		orange	Action 1 (Factory setting: fast data transfer)
		red	Action 2 (Factory setting: device stop/start)
		green flashing	Power supply ok
		green	Cloud connection ok
LED 2 (Status)		green	PQ ok
		orange	e.g. PQ in tolerance
		red	PQ out of tolerance

Further signals can be configured. The assignment of LED 2 (Status) to a measuring function is done via the device settings.

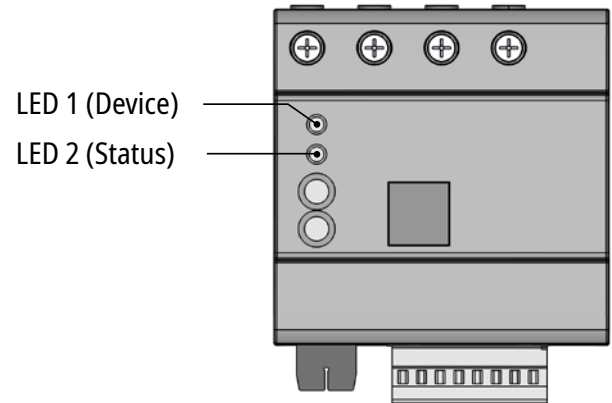

User interface – Push buttons

Two keys are available for operation on the device.

These have different functions depending on how long they are pressed.

Button	Duration	Function
1 (Option)	Short (<1 sec)	Start fast data transfer
	Long (>5 sec)	Device stop/start
	Long (>10 sec)	Reset to factory settings
2 (Basic)	Short (<1 sec)	Activate web server
	Long (>5 sec)	Device reset

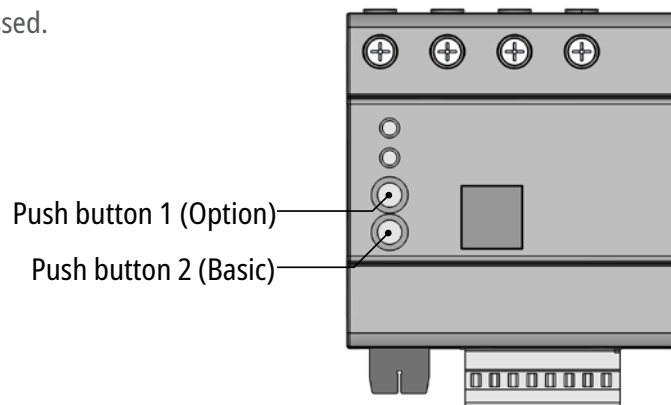

9. Functionality

9.2 Block diagram

DRC SD 2 1

Power supply extern
via connection +U_e, -U_e

DRC SD 1 1:

Power supply via connection
L1 Auxiliary voltage Out via
connection +U_e, -U_e

Voltage measurement L1/L2/L3/N

Current measurement
L1/L2/L3/N

Impulse current
measurement

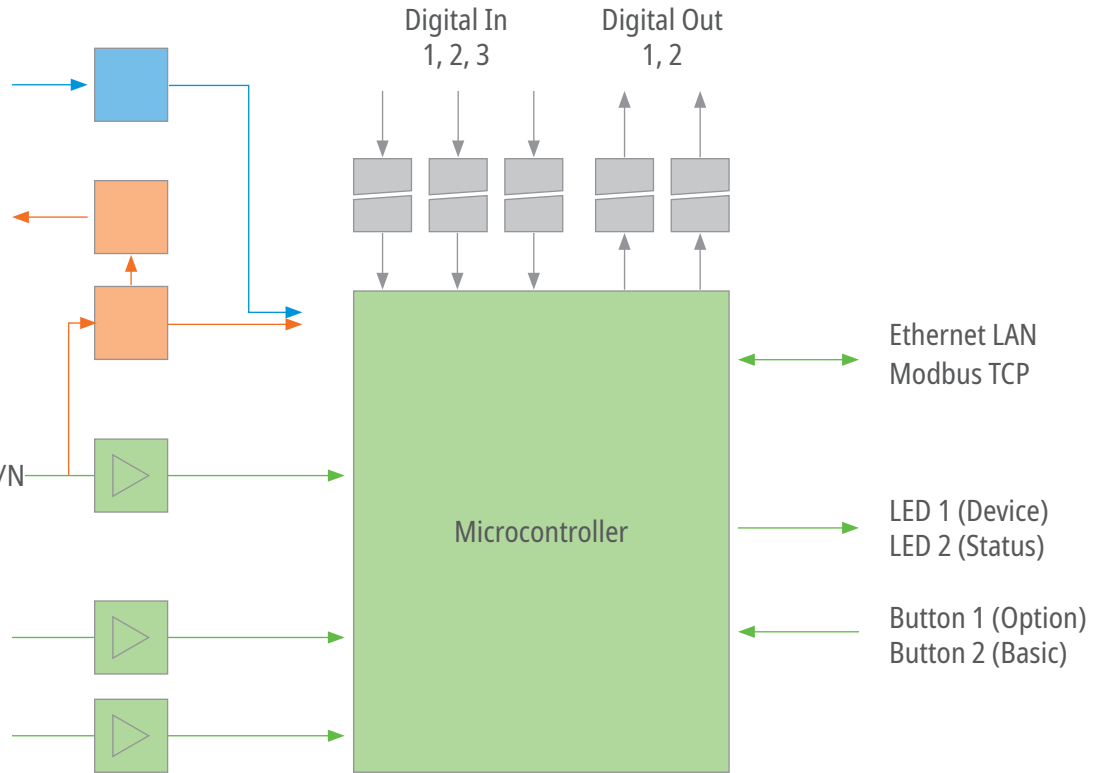

9. Functionality – Measured values

9.3 Measured values

The DEHNrecord SD records power quality data for both continuous measured variables and event-related measured variables. It also provides energy and performance data as well as the current status of the digital inputs and outputs.

The following list provides an overview of the measured variables.

A detailed list with names and descriptions of the individual measured variables can be found in the Modbus manual

Power Quality:

- Voltage magnitude $U_{(PQ)}$
- Frequency f
- Flicker P_{st} , P_t
- Voltage unbalance u_2 , u_0
- Voltage harmonics $U_{h2} \dots U_{h50}$
- Voltage interharmonics $U_{ih2} \dots U_{ih50}$
- Mains signalling voltage
- Voltage dip/swell/interruption
- Rapid voltage changes

Power frequency overvoltages:

- Events according to EN 50550
- Individual setting: e.g. undervoltage

Digital I/O:

- Digital inputs
- Digital outputs

Energy:

- Voltage U
 - Current I
 - Apparent power S
 - Active power E
-
- Active power P^*
 - Reactive power Q^*
 - Power factor PF^*

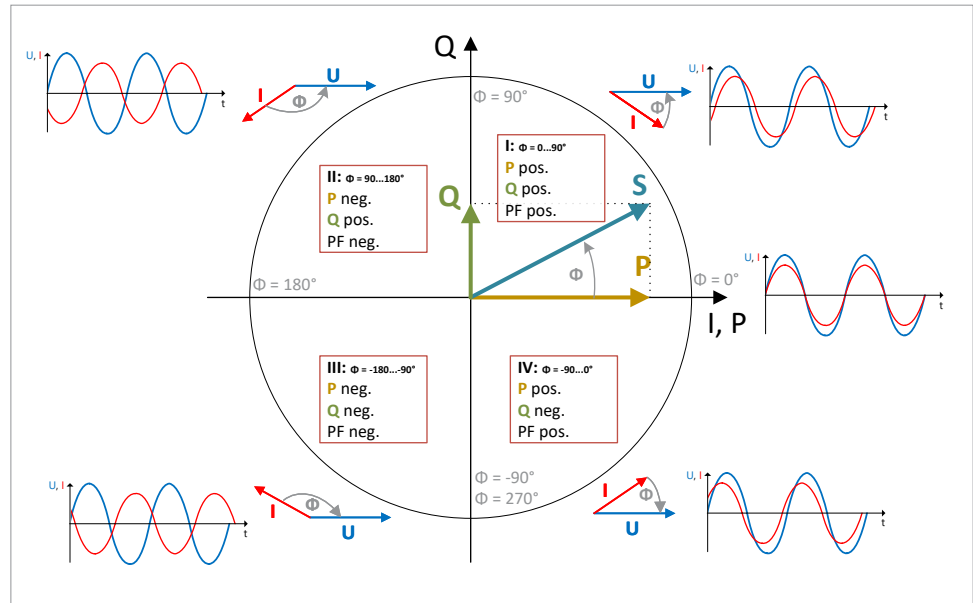

* Information about the sign of the measured values P, Q and PF

9.4 Modbus

Detailed instructions for communication with the DEHNrecord SD via Modbus TCP can be found in the separate Modbus instructions. It contains a list and description of all Modbus registers and measured variables.

The file is available on the internet page <https://www.dehn-international.com/en/dehnrecord-smart-device-power-quality>

Modbus TCP	
Operating mode	TCP
Bus participant role	Slave
Commands	See Modbus instructions

9.5 Communication via the network

Ports and protocols used by the DEHNrecord SD for communication via the network:

Internal communication

Port	Protocol	Description/Example
53	DNS	Resolve network name "DRC-SD serial number"
80	HTTP	Communication to the web server
123	NTP	Time synchronization
502	Modbus	Modbus/TCP-communication
67/68	DHCP	Obtain IP address via DHCP
161	SNMP	Registration of the device e.g. in Windows Explorer to access the web server from there
1900	SSDP	Supports the function "universal plug and play"
	ICMP	For ping command

External communication

Port	Protocol	Description/Example
123	NTP	Time synchronization (if external time server is used)
443	HTTPS	Communication to the target system (Azure, Cloud) target: dkg-sdc-prod-iothub-devices-01.azure-devices.net
8883	MQTT/TLS	

9. Functionality – Measured values

9.6 Firmware update

DEHNrecord SD in online mode

As soon as the DEHNrecord SD is connected to the DEHNmonitor PQ cloud (www.dehn.de/powerquality-monitor), all firmware updates are automatically downloaded and installed. As soon as the device is registered as a measurement site, a distinction can be made between all and only necessary updates for the automatic update.

DEHNrecord SD in offline mode

If the DEHNrecord SD is operated without an internet connection, firmware updates can be downloaded manually as a file and installed via the web server. The following steps are necessary for this:

Step 1:

Download current firmware in the Service/Downloads area of the DEHNmonitor PQ:
www.dehn.de/powerquality-monitor (login required).

NOTE:

For this, you need the serial number and the four digits after the serial number.

These are only printed on the device itself! Example: Example: „0000“ in FHA12345678-0000“.

The file is only applicable to the DEHNrecord SD with this serial number,
i.e. an individual file must be downloaded for each device.

Step 2:

Open the web server of the DEHNrecord SD and select the downloaded file under Device/Firmware Update and start the update.

10. Device settings

10.1 Device settings expert mode

Device settings can be made on the web server of the DEHNrecord SD itself, via Modbus or via the cloud. For easy operation, some more complex setting options are hidden by default. If the expert mode is activated, all setting options can be displayed.

10.2 General

In addition to a description, the path for the configuration of power quality parameters can be specified here.

Path for PQ configuration	Note
Modbus	Limit values can be set via the Modbus
Cloud	Limit values can be set via the cloud

10.3 LED indicator

The display of LED 2 (Status) can be configured individually. The following options are available for this purpose:

Configuration LED 2 (Status)	green	yellow	red
PQ status standard	OK	Event occurred	Violation of a limit value
PQ status individual	OK	Event occurred	Violation of a limit value
POP display	OK	Event occurred	-
Input 1	"0"	"1"	-
Input 2			-
Input 3			-
Off	-	-	-

10. Device settings

10.4 Digital inputs, digital outputs and logic

Digital inputs

For the three digital inputs (input 1, 2 and 3), both an event type and an event trigger can be defined.

The event type describes in which form and when events are transmitted to a cloud per 10-minute interval:

Event type	Transmission
Off	No event is transmitted
Instant event	Only the first event is transmitted immediately
Collection event	The number of events is transmitted at the end of the 10-minute interval

The event trigger defines the kind of signal change to which the inputs react:

Event trigger	Input reacts to signal change
On change	at rising and falling edge
Rising edge	with rising edge
Falling edge	with falling edge

Digital outputs

For the two digital outputs, a source and an active time can be defined in addition to the function.

Parameters

The function describes the behavior of the respective digital output.

Parameters	Setting options			Default value
Function	Off	Contact normally open (NO)	Contact normally closed (NC)	Off

The active time defines how long the output remains activated after an event occurs in the selected source.

As soon as another event occurs within this time, the time window is restarted.

Parameters	Setting range	Default value
Active time	100 ... 2000 ms	1000 ms

The digital output responds to various internal or external event sources. The following options are available as sources:

Source	Reaction to
Off	-
Input 1	Event at digital input 1, behavior of the input adjustable
Input 2	Event at digital input 2, behavior of the input adjustable
Input 3	Event at digital input 3, behavior of the input adjustable
POP function	Detection of a power frequency overvoltage or individually defined voltage (see chapter "power frequency overvoltages (POP)")
PQ standard	Violation of a PQ limit according to EN 50160
PQ individual	Violation of a PQ limit according to individual set of limit values
Impulse	Violation of an impulse limit
Energy/current	Events caused by the current and energy measurement (see chapter 10.6 current measurement)
Device	Events generated by the DEHNrecord SD itself, such as cloud connection established or action by pressing a button on the device (Action 1, Action 2), firmware update successfully performed, ...
Cloud2Device	A command controlled from the cloud
Logic	Digital output functions as output of the LOGIC function

10. Device settings

Logic

The internal logic module has four inputs and one output.

These can be configured individually and the function of the logic module can also be set.

Input 1, 2 and 3 designate the digital inputs of the DEHNrecord SD.

Input 4 represents an internal event source.

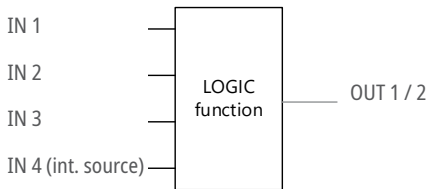

To link output 1 or 2 with the logic, select “Logic” as the source under the setting for the respective output.

Parameters	Values
Function	Off, AND, OR, XOR, NOR, NAND, XNOR
Input 1, 2 and 3 (digital inputs)	off, normal, inverted
Input 4 (internal source)	off, POP, PQ standard, PQ individual, impulse, energy/current, device

10. Device settings

10.5 Network

Network settings can only be made in the web server of the DEHNrecord SD. Saved changes are applied after a restart of the device.

A connection to a time server (SNTP) is required for the intended use of DEHNrecord SD.

The addresses and ports required for this must not be blocked in the network. The ports are listed in chapter 9.5 “Communication via the network”.

Parameters	Setting range	Default value
DHCP	on/off	off
DNS Server 1 (IP of the DNS server for static settings)	0.0.0.0 ... 255,255,255,255	8.8.8.8
DNS Server 2 (IP of the DNS server for static settings)		1.1.1.1
Static IP (if DHCP is disabled)		169.254.0.10
Static IP gateway (if DHCP is disabled)		0.0.0.0
Static IP netmask (if DHCP is disabled)		255.255.0.0
Time server 1 (SNTP)		de.pool.ntp.org
Time server 2 (SNTP)		ptbtime1.ptb.de
Time server 3 (SNTP)		ptbtime2.ptb.de
Time server 4 (SNTP)		ptbtime3.ptb.de
Device name (the name under which the device is visible in the network if DHCP is activated)	Not adjustable	DRC-SD-FHAXxxxxxxx (FHAXx... = Serial number)
MAC adress	Not adjustable	Device-dependent
Timeout web server (time in seconds after the web server is deactivated)	120 ... 3600 s	600 s

Cloud settings (only accessible in web server, expert mode)

MQTT server Address: dkg-sdc-prod-iotHub-devices-01.azure-devices.net

MQTT username: dkg-sdc-prod-iotHub-devices-01.azure-devices.net/FHAxxxxxxx/?api-version=2019-10-01

FHAxxxxxxx = serial number of the device

10. Device settings

10.6 Power frequency overvoltages according to EN 50550 - POP

Function

The DEHNrecord SD detects power frequency overvoltages as defined in the EN 50550 standard.

In addition to the four voltage time windows specified by the standard, a fifth detection criterion can be configured.

This can also be used to detect undervoltage.

Parameter for power frequency overvoltages according to EN 50550

Selectivity factor

This factor can be used to determine the time at which the digital output is switched if "POP" is set as the source for it. By default, this is set to 1, which corresponds to half of the voltage-time window minus the switch-off time reserve.

Switch-off time reserve

This time serves as the reserve, which a potential protective device requires from recording a trigger signal to switch off.

Parameters	Setting range	Default value
Selectivity factor	0 ... 2	1
Switch-off time reserve	0 ... 0.13 s	0.02 s

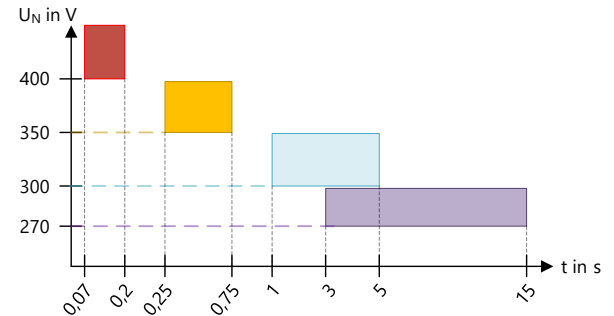

Voltage time window from EN 50550 within which a POP main protective device must trip.

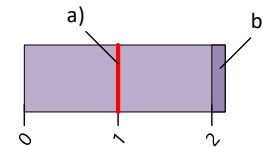

Illustration of the selectivity factor a) as well as the switch-off time reserve b).

Parameters for individual recording criteria

Individual recording criterion active

Herewith the additional criterion for a power frequency overvoltage or undervoltage can be activated. The selectivity factor and the switch-off time reserve do not apply to this criterion.

Voltage

Individual voltage threshold at which an event is triggered.

Status/Direction

Setting whether triggering occurs when the voltage threshold is exceeded or not reached.

Duration

Delay time after which triggering occurs when the voltage threshold is exceeded or not reached.

Individual recording criterion	Setting range	Default value
Voltage	2 ... 440 V	325 V
Duration	0.04 ... 3600 s	1 s
Status/Direction	Trigger when exceeding or falling below the voltage threshold	exceeding

10.7 Current measurement

Measured variables

The following measured variables are recorded via the respective measuring circuits: voltage U, current I, active power P, apparent power Q, reactive power S, active power E, frequency f.

Base values are the effective values over 200 ms or 10 s for the frequency.

The further mean values are calculated from this (3 s, 5 min.).

Measuring intervals

For data provided in the cloud or via Modbus, a measuring interval of 5 minutes is defined.

This measuring interval also corresponds to the averaging time over which the average value is calculated for each measured variable.

Fast data transfer

During “fast data transfer”, the 3-second average values (10 s for frequency) are transferred to the cloud. There they can be visualized instantaneously and are also available as an event for later viewing.

Events

An event type with an associated limit can be configured for each phase individually and independently of one another. The following event types fall under the event category En.

Event types	configurable for current measurement input				configurable limit value range
	L1	L2	L3	N	
Current	✓	✓	✓	✓	$0.05 I_N \dots 2 I_N$
Effective power	✓	✓	✓	–	$0.5 U_N \cdot 0.05 I_N \dots 1.5 U_N \cdot 1.5 I_N$
Reactive power	✓	✓	✓	–	
Apparent power	✓	✓	✓	–	
Reversal of current direction	✓	✓	✓	✓	--without--
Zero current	✓	✓	✓	✓	$0.005 I_N \dots 0.2 I_N$
Active power momentarily	over 3 phases			–	0 ... 999 999 kWh
Active power meter	over 3 phases			–	0 ... 9 999 999 kWh

If an event is recognized, i.e. the recorded measured value exceeds or falls below the associated limit or fulfills the underlying condition, this event is provided with the corresponding data (event type and category, time stamp, parameters (measured value)) and included in the transfer to the cloud for archiving and evaluation. It is also available for retrieval in the corresponding Modbus register. Via the configuration of the device, an event category can be assigned to the status LED and / or to one of the two digital outputs and / or for the logic connection of the digital Inputs and / or to an email notification channel. This means that with each event the output channel is updated / activated according to its configuration.

10. Device settings

10.8 Mains signalling voltages

Mains signalling voltages are used by the network operator to communicate via the energy network using ripple control signals. These differ regionally. Global settings (frequency of the mains signalling voltage, duration and trigger threshold) must be made there for correct detection of these signals. These apply both to the standard parameter set according to EN 50160 and to the individual PQ parameter set.

Frequency of the mains signalling voltage

Frequency of the ripple control signal, the 3-second mean value of which is compared with the limit.

Duration

Period over which compliance with the limit is monitored.

Trigger threshold

If this is exceeded, the duration of the monitoring starts. Specified as a deviation in % of the nominal voltage.

You will find the setting range and default values in the chapter “PQ configuration” on page 51.

10.9 Factory reset

To reset the device to the factory settings, press button 1 (Option) for at least 10 seconds.

This is also possible via the web server in the “Device - Factory settings” menu using the web server password.

As soon as both LEDs go out, DEHNrecord SD restarts and is reset to the default values.

Warning: this will also reset the network settings.

Limits and parameters for the evaluation of the power quality (PQ) are configured here according to individual criteria.

11. PQ configuration

The PQ configuration is done either via Modbus or via the cloud (= default setting).
The path can be changed in the device settings under general at “Path for PQ configuration”.

11.1 General

Observation period

The status of the power quality is evaluated over this period. One day or one week can be set.

Observation start

Can be set to “Fix” (manually adjustable start time) or to “Auto” (next possible start time).

Consider flagged PQ measuring intervals

Measuring intervals can be marked according to the flagging concept described in EN 61000-4-30. Flagged data indicate that they may be unreliable. The user is free to take them into account or not.

Time periods

For various power quality characteristics, time periods can be defined within an observation period in which the limits must be observed. This time period is specified in % of the selected observation period and indirectly defines the permissible number of events within an observation period.

11.2 Voltage magnitude

The measured voltage magnitude is defined by the rms value of the voltage between the outer and neutral conductor (or outer and PEN conductor). It is averaged over a time window of 10 minutes.

Limits

Two sets of limit values are available. For each, in addition to a minimum and maximum, there is also a period of time during which the limits must be observed before violations occur. The period is given in % of the selected observation period.

11. PQ configuration

11.3 Frequency

The frequency of the mains voltage is determined over a time window of 10 seconds in each case.

Limits

Two sets of limit values are available.

For each, in addition to a minimum and maximum, there is also a period of time during which the limits must be observed before violations occur.

The period is given in % of the selected observation period and the minimum and maximum in deviation from the nominal value.

11.4 Flicker

Flicker is visually perceptible change in luminosity of light sources.

A distinction is made between short term flicker P_{st} (10-minute value) and long term flicker P_{lt} (2-hour value).

Limits

Limits can be defined for flicker (short and long term).

In addition, a period can be defined in which the limits must be observed before a violation occurs.

The time period is specified in % of the selected observation period.

11. PQ configuration

11.5 Voltage dip, voltage swell, voltage interruption

Half-period rms values are measured to record these characteristics.

The rms value of the voltage is calculated over an entire period and updated after every half period.

This method combines the accuracy of a full-cycle measurement and the speed of a half-cycle measurement.

11.6 Voltage dip

As soon as the voltage drops below a defined threshold, this is evaluated as a voltage dip.

Limits

In addition to the threshold, a hysteresis can also be configured individually.

Voltage dips are categorized according to table 2 of EN 50160 and the number of dips permitted before it is categorized as a violation can be defined for each individual category.

In addition, there is a field for categories that are not defined in the table.

11.7 Voltage swell

If the voltage exceeds a defined threshold, a voltage swell is detected.

Limits

In addition to the threshold, a hysteresis can also be configured individually.

Voltage swells are categorized according to table 3 of EN 50160 and the number of swells permitted before it is categorized as a violation can be defined for each individual category.

There is also a field for categories not covered by the table.

11. PQ configuration

11.8 Voltage interruption

An interruption of the voltage is detected as soon as it falls below a certain threshold on all phases.

Limits

In addition to the threshold, a hysteresis can also be configured individually. Additionally, a time duration can be defined, where an interruption is categorized as either short or long interruption. It is also possible to define a permitted number of interruptions per category before it is categorized as a violation.

11.9 Unbalance

The unbalance of a three-phase system is represented by the quantity u_2 using the symmetrical components. This represents the ratio of the negative sequence component to the positive sequence component in percent.

Limits

In addition to the permitted maximum, a time period can be defined in which the limits must be observed before a violation occurs.

11. PQ configuration

11.10 Total harmonic distortion THD, harmonics, interharmonics

The distortion of the mains voltage is described with the help of harmonics and interharmonics.

Harmonics are integer multiples of the fundamental and are characterized by an order $h \rightarrow$ e.g. U_{h3} for the third order harmonic (in the 50 Hz network this would be 150 Hz).

Interharmonic voltages are non-integer multiples of the fundamental.

The total harmonic distortion THD (also known as distortion factor) is calculated, in simplified terms, from the sum of the root mean square of the harmonic to fundamental ratios up to a certain order h .

Limits

In addition to the maximum permitted for each harmonic and interharmonic, a time period can be defined in which the limits must be observed before a violation occurs.

The maximum is given as a % value to the rms value of the fundamental (50 Hz).

In addition, the highest order up to which the individual harmonics are included in the calculation of the THD can be defined.

11.11 Mains signalling voltages

Power supply companies often use their network for communication purposes.

Mains signalling voltages, so-called ripple control signals, are used for this purpose.

The frequency of the mains signalling voltage is the carrier frequency of the modulated signal.

Parameters

In addition to the frequency of the mains signalling voltage itself, the duration and trigger threshold from which a mains signalling voltage is detected can be set individually. The duration describes the time window in which monitoring starts after the trigger threshold has been exceeded.

These parameters are defined under Device settings, as they apply to both the standard and the individual limit value.

11. PQ configuration

Limits

For the evaluation, both a limit value and a time period can be defined in which the limit value must be adhered to before a violation occurs.

The maximum level of a mains signalling voltage depends on the selected frequency of the mains signalling voltage.

The max. limit value of this voltage is automatically generated based on the specifications of EN 50160 Fig. 1.

11.12 Rapid voltage changes

A rapid voltage change is when the voltage magnitude is at a nearly constant level for a period of time and suddenly a voltage change occurs that significantly deviates from that level.

Limits

The voltage change level defines the limit from which height the deviation from the constant level is considered as a rapid voltage change.

This limit is given in % of the nominal voltage.

In addition, a hysteresis can be defined for this value and a permissible number of rapid voltage changes in the selected observation period.

In addition, a minimum and a maximum must be defined, above or below which the rapid voltage change is categorized as a dip or swell. These values are identical with the thresholds of the latter.

11.13 Values for PQ characteristics

PQ feature	Parameters	Setting range	Default value (EN 50160)
Voltage magnitude	Period 1	0 ... 100 %	95 %
	Max. 1	+0.1 ... +25 %	+10 %
	Min. 1	-25 ... -0.1 %	- 10 %
	Period 2	0 ... 100 %	100 %
	Max. 2	+0.1 ... +25 %	+10 %
	Min. 2	-25 ... -0.1 %	- 15 %
Frequency	Period 1	0 ... 100 %	99.5 %
	Max. 1	+0.1 ... +25 %	+1 %
	Min. 1	-25 ... -0.1 %	-1 %
	Period 2	0 ... 100 %	100 %
	Max. 2	+0.1 ... +25 %	+4 %
	Min. 2	-25 ... -0.1 %	-6 %
Flicker (long term)	Period	0 ... 100 %	95 %
	Max.	0.2 ... 10	1.0
Flicker (short term)	Period	0 ... 100 %	-
	Max.	0.2 ... 10	-

PQ feature	Parameters	Setting range	Default value (EN 50160)
Voltage dip	Number	0 ... 1000	-
	Threshold	-50 ... -1 %	-10 %
	Hysteresis	0 ... 10 %	2 %
Voltage swell	Number	0 ... 1000	-
	Threshold	50 ... 1 %	10 %
	Hysteresis	0 ... 10 %	2 %
Voltage interruption	Number	0 ... 1000	-
	Threshold	1 ... 10 %	5 %
	Hysteresis	0 ... 10 %	2 %
	Duration (short term / long term)	1 ... 600 s	180 s
Unbalance	Period	0 ... 100 %	95 %
	max.	0.5 ... 5 %	2.0 %
THD	Period	0 ... 100 %	95 %
	max.	0.1 ... 20 %	8 %
	Order h Up to this order, the individual harmonics are taken into account for the calculation of the THD.	0 ... 50	40

PQ feature	Parameters	Setting range	Default value (EN 50160)
Harmonics	Period (valid for all orders)	0 ... 100 %	95 %
	max.	0 ... 20 %	see table H
Interharmonics	Period (valid for all orders)	0 ... 100 %	-
	max.	0 ... 20 %	-
Mains signalling voltage	Period	0 ... 100 %	99 %
	max.	0 ... 10 %	nach EN 50160
	Frequency of the mains signalling voltage <small>(to define under device settings)</small>	100 ... 3000 Hz	175 Hz
	Recording duration <small>(to define under device settings)</small>	3 ... 120 s	120 s
	Trigger threshold <small>(to define under device settings)</small>	0.3 ... 4.9 %	4.5 %
Rapid voltage changes	Number	0 ... 1000	-
	Level	1 ... 6 %	5 %
	Hysteresis	0.5 ... 3 %	2.5 %
	min. (= threshold for voltage dip)	-50 ... -1 %	-10 %
	max. (= threshold for voltage swell)	1 ... 50 %	10 %

Table H: Limits for individual harmonics

Order h	2	3	4	5	6	7	8	9	10	11	12	13	14	15	16	17	18	19	20	21	22	23	24	25
Max. in %	2.0	5.0	1.0	6.0	0.5	5.0	0.5	1.5	0.5	3.5	0.5	3.0	0.5	1.0	0.5	2.0	0.5	1.5	0.5	0.75	0.5	1.5	0.5	1.5

Power supply	DRC SD 1 1 (Part No. 910 920)	DRC SD 2 1 (Part No. 910 921)
Power supply	230 V _{AC} (via L1 and N)	24 V _{DC} SELV 
Input voltage range	185 - 265 V _{AC} , 47 - 53 Hz	18 - 30 V _{DC}
Current consumption	30 mA (max.)	100 mA (max.)
Power consumption	8 W (max.)	3 W (max.)
Max. permissible input voltage in the event of a fault (with disconnected neutral)	400 V _{AC}	
Supply voltage buffering in case of power failure	min. 5 seconds	depending on power supply
Supply voltage buffering in case of voltage dip up to 70 %	min. 60 seconds	depending on power supply
Permitted overvoltage	463 V _{AC} for 5 seconds	

Measurement inputs L1/L2/L3/N	
Nominal input voltage	230/400 V _{AC}
Nominal input frequency	50 Hz
Isolation: connections to digital inputs/outputs and to DC in/out	galvanically isolated
Connecting cable	1.5 mm ² - 6 mm ² (fine-stranded/stranded wire), 10 mm ² (solid wire)
Backup fuse	Suitable for the connecting cable, e.g. for 1.5 mm ² → B 16 A
Backup fuse in combination with an SPD	The specifications of the respective SPD must be observed

Analog inputs	
Impulse current measurement (1 x)	Impulse current sensor DRC SD ICS 100 for recording of surge currents up to 100 kA
Voltage measurement (3 x)	Recording the AC mains voltage of all three phases
Current measurement (4 x)	External designated current sensors to detect AC line currents of all three phases plus neutral

Interfaces	
Ethernet (1x RJ45)	Query and configuration by ext. controllers (Modbus TCP, Slave), cloud connection, communication with internal web server
Digital Inputs (3 x)	Recording digital signals Nominal voltage 24 V _{DC} , max. 30 V _{DC} ; on > 8.5 V; off < 7.35 V
Digital Outputs (2 x)	Output of a digital signal via a potential-free contact (max. 24 V _{DC} , max. 0.5 A continuous, max. 2 A for 100 ms)

User interface	
Push buttons (2 x)	Control during operation
LEDs (2 x RGB)	Display of different states

Standards	
Safety (MSRL)	EN 61010-1: 2010 + Cor. 2011 EN 61010-2-030: 2010 + Cor. 2011
EMC (MSRL, industry, power plants)	EN 61326-1: 2013 EN 61000-6-5: 2015 + AC: 2018
Power quality (devices/features)	EN 62586-1: 2017 EN 61000-4-30: 2015 EN 50160: 2010 + Cor.: 2010 + A1: 2015 + A2: 2019 + A3: 2019
Power frequency overvoltage / POP	EN 50550: 2011 + AC: 2012 + A1: 2014

Device general	DRC SD 1 1 (Part No. 910 920)	DRC SD 2 1 (Part No. 910 921)
Dimensions B x H x T	90 (5 DIN modules) x 90 x 65 mm	
Weight	400 g (500 g incl. packaging)	335 g (435 g incl. packaging)
Enclosure - material	PA 12, grey	
Enclosure - impact resistance	IK 06	
Installation point	Indoor	
Mounting type	DIN rail in main or sub-distribution, operation with panel cover	
Connection supply/mains voltage measurement	Busbar 2-pol./4-pol., solid wire 2-pol./4-pol.	
Protection class	IP20	

Possible combinations	
With SPD (product family), directly with busbar	DEHNventil, DEHNshield, DEHNguard, DEHNBloc modular
With SPD (product family), freely wired	DEHNvenCI, DEHNBloc Maxi, DEHNrail

Ambient conditions (defined for device class PQI-A-FI1 according to DIN EN 62586-1)	
Ambient temperature: Storage and transport	-40 °C to +70 °C
Ambient temperature: nominal operating range	-10 °C to +45 °C
Ambient temperature: operating limit range	-25 °C to +55 °C
Relative humidity: 24-h average	Storage and transport: from 5 % to 95 % Indoor operation: from 5 % to 95 % Note: no condensation, no ice
Contamination by dust, salt, smoke, corrosive/flammable gas, vapors	no significant pollution
Vibrations, seismic shocks	IEC 60721-3-1, IEC 60721-3-2, IEC 60721-3-3
Electromagnetic immunity	EN 61000-6-5/2016-07
Operating height	max. 2000 m above sea level
Pollution degree	2
Overvoltage category (related to the mains supply voltage)	III, together with SPD: IV
Measurement category	300 V CAT III, together with SPD: 300 V CAT IV

Voltage measurement inputs	
Connection to TT and TN-S system	L1, L2, L3, N
Connection to TN-C system	L1, L2, L3, PEN
Connection to IT system	No use possible
Cross-sectional area	1.5 - 6 mm ² fine-stranded/stranded wire 1.5 - 10 mm ² solid wire stripping length 16 mm
Busbar	Copper, 16 mm ² , contact stud length ≥ 15.5 mm, exit at top
Busbar, for use with DEHNshield, DEHNguard (4 DIN modules)	MVS 4 8 11, 910 814
Busbar, for use with DEHNventil, DEHNBloc modular (8 DIN modules)	MVS 4 56, 910 614
Parallel connection busbar and line	possible
Input voltage Lx – N	230 V _{eff} , 50 Hz, max. 300 V _{eff}
Input rated voltage/measurement category	300 V CAT III
Input rated voltage/measurement category together with SPD (U _p ≤ 2.5 kV)	300 V CAT IV

Detection of power frequency overvoltages	
Limits	according to EN 50550
Evaluated voltages	L1 - N, L2 - N, L3 - N
Characteristic for digital output signal	> 275 V / 3 ... 15 s; > 300 V / 1 ... 5 s; > 350 V / 0.25 ... 0.75 s; > 400 V / 0.02 ... 0.07 s; individual 2 ... 440 V / 0.04 ... 3600 s

Current measurement inputs for designated, external split core current transformers or Rogowski coils

Number	4
Cross-sectional area	0.08 - 1.5 mm ² solid-wire, fine-stranded-wire 0.25 - 1.5 mm ² with ferrule stripping length 8 - 9 mm
Parameterization	via web server, cloud or Modbus
Isolation current measurement input	no galvanic isolation

Split core current sensors, DRC SD SCS 100 (Part No. 910 936)	
Measuring range	0 - 100 A (120 A max.), 50 Hz
Bandwidth	1.5 kHz
Accuracy class	class 1 according to IEC 61869-2
Ring diameter inside	16 mm
Dimensions (W x D x H)	40.8 x 33.2 x 56.1 mm
Connection cable length	1 m
Attachment to the conductor to be measured	with 2 cable ties
Weight	120 g
Safety/insulation, touchability of sensors	300 V CAT III
Safety/insulation, to the live conductor	300 V CAT III

Current sensors – Rogowski coil, divisible, flexible, DRC SD RCS 1000	Part No. 910 937	Part No. 910 938
Measuring range	0 - 1000 A (2000 A max.), 50 Hz	
Bandwidth	50 kHz	
Accuracy class	class 1 according to IEC 61869-2	
Ring diameter inside	150 mm	
Dimensions	Ø 10 mm	
Connection cable length	3 m	1 m
Weight	250 g	
Safety/insulation, touchability of sensors	300 V CAT III	
Safety/insulation, to the live conductor	1000 V CAT III or 600 V CAT IV	

Impulse current measurement input for designated, external impulse current sensors

Number	1
Cross-sectional area	0.08 - 2.5 mm ² solid-wire, fine-stranded-wire 0.25 - 1.0 mm ² with ferrule stripping length 6 - 7 mm
Connection type	push-in
Measuring range	0 ... 100 kA
Voltage magnitude resolution	100 A
Sampling rate	1 μs
Curve shape	8/20 - 10/350 μs
Recording time	max. 500 ms
Impulse values (calculated)	I_{peak} , Q_{ges} , T_r , T_w , category duration
Trigger threshold voltage level	parameterizable via internal web server or via the cloud

Impulse current sensor – DRC SD ICS 100 (Part No. 910 935)	
Recording range I_{peak}	50 kA, waveform 8/20 - 10/350 μ s
Bandwidth	50 kHz
Attachment to the conductor to be measured	with 2 cable ties (included)
Dimensions (W x D x H)	23 x 30 x 75 mm
Connection cable length	3 m (incl. fastening and kink protection)
Weight	25 g
Safety/insulation, touchability of sensors	300 V CAT III

Installation may only be carried out on insulated conductors which are not dangerously live.

Digital outputs (2 x)	
Type	PhotoMOS relay, bidirectional
Voltage max.	30 V
Current max.	500 mA
Power max.	500 mW
Switch-on resistance max.	150 mΩ
Polarity	arbitrary
Connection cable length	max. 30 m
Isolation: connections to voltage measurement inputs	300 V CAT III
Isolation: Connections to other digital inputs/outputs	galvanically isolated
Isolation: connections to external DC supply	100 V

Digital inputs (3 x)	
Type	multifunctional
Voltage	nominal voltage 24 V _{DC} , max. 30 V _{DC} ; on > 8.5 V; off < 7.35 V
Current consumption	max. 10 mA
Polarity	arbitrary
Isolation: connections to voltage measurement inputs	300 V CAT III
Isolation: Connections to other digital inputs/outputs	galvanically isolated
Isolation: connections to external DC supply	100 V

Measurement power quality	
Measurement method	EN 61000-4-30:2015, class A
Evaluation	EN 50160: 2010 + Cor.: 2010 + A1: 2015 + A2: 2019 + A3: 2019 or individually parameterizable
measurement	3-phase (L1, L2, L3, N/PEN)
Nominal value voltage/frequency	230 V _{eff} / 50 Hz

Measurement power quality	Measuring range	Measurement accuracy/ method
Voltage magnitude	10 - 150 % of U _N	± 0.1 % of U _N
Frequency	± 15 % of f _N	± 10 mHz
Flicker	0.2 - 10 P _{st}	EN 61000-4-15
Dip, swell	10 - 150 % of U _N	0.2 % of U _N , ± 1 period
Interruptions	< 10 % of U _N	
Unbalance	0.5 - 5 % of u ₂ and u ₀	0.15 %
Harmonics, Interharmonics	Order 2. - 50.	EN 61000-4-7 (class I)
Mains signalling voltage	0 - 15 % von U _N	EN 61000-4-30
Rapid voltage changes	± 1 % of U _N to dip/swell	0.2 % of U _N

13. Maintenance

The maintenance of the device is recommended no later than 5 years from handover and thereafter regularly at least every 5 years after the last maintenance.

Should the measurement results deteriorate persistently before reaching a maintenance date, early maintenance of the device is recommended.

13.1 Check

A test could be carried out, for example, by a parallel measurement with a reference device.

Reasons for premature maintenance may include:

- The device was exposed to temperatures outside the tolerance range for a long time.
- Frequent and extraordinary EMC phenomena

Please note:

The reason for a permanent deterioration of the measurement results may be solely the actual deterioration of the power quality without the need for premature maintenance.

13. Maintenance

13.2 Cleaning

The device must not be cleaned when it is connected.

When not connected, the device can be cleaned with a cloth dampened with water.

No liquids may penetrate the device.

13.3 Dismantling

 **ATTENTION**
Risk of electric shock
A DEHNrecord SmartDevice may only be dismantled by a qualified electrician!



IEC 60417-6182:
Installation,
electrotechnical expertise

13.4 Disposal



The device should not be disposed of in the normal household waste.

For more Information please refer to our website: www.dehn-international.com